

KRC[®] 金洛卡

全屋定制系统

Whole-House Custom System 

极简主义 / 铝材定制家居
Customized Minimalist aluminum furniture

Introduction



公司简介

金洛卡精密五金有限公司地处国内大型铝合金型材生产基地——佛山市南海区狮山镇。本公司成立于2008年，有着悠久的发展历程。公司占地面积1万多平方米，现有员工100多名，专业技术人员40多名。本公司拥有领先国内的进口数控加工生产设备和较强的生产实力和技术水平。目前我可以生产铝合金型材、深加工铝合金产品为主。凭着强大的研发能力、先进的技术力量和优良的产品质量，已逐步成为国内外整体家居行业的优质供应商。多年来，本公司不断加强和强化生产管理；开拓创新。

本着以质量为本、客户至上的目标，奉行信誉第一为宗旨。产品质量已达到国际一流水平，得到广大客户的认可，在国内市场上取得一定影响力。今后我们还会继续传承优良作风。让客户更加满意，更加放心。

KRC PRECISION HARDWARE CO.,LTD.

is located in the domestic large-scale production base of aluminum profiles - shi shan Town, Nanhai District of Foshan City. The company was founded in2008, it has a long development process. The company covers an area of over 10,000 square meters, more than 100 employees, more than 40 professional and technical personnel. The company introduced a leading domestic CNC machining equipment from Germany, Taiwan, has a strong production strength and technological level. Division I to produce aluminum extrusions, aluminum deep-processing products.

corporate culture

企业使命

让每家每户用上更好的家居五金

企业核心价值观

品质为本，匠心铸魂，诚信为先，创新务实。

品质为本：品质是企业的根本，是品牌的基石，同时，也是我们最有力的后盾。

匠心铸魂：匠心是虚心，是恒心，是细心。在企业飞速发展的时候，我们要做到虚心对待一切。在企业稳步向前的时候，我们要做到对产品的每一个细微之处精益求精。

诚信为先：诚实守信，是我们最初创建品牌的道德标准，是企业和员工的生存之本，在任何时候，它都将是我们的坚不可摧的那道底线。

创新务实：持续提供超越客户期望的精品和优质的服务，企业稳健发展的同时与客户共赢。

企业理念

我们始终坚持在不违背企业核心价值观的前提下，追求更远大的发展。为了创建一个让客户和员工都受益的平台而努力。为了让每家每户用上更好的家居五金而努力。这是我们的使命，我们会恪守她，并信奉她。



企业愿景

在过去的每一天，我们都在致力于如何做好家居五金配件，如何给客户带来真实舒适的使用体验。

现在，我们正在打造业内一流的家居配件系统，我们不仅要为客户提供优质的家居五金配件，同时也提供全屋铝型材家居定制。希望让更多的客户感受到我们的产品带来的舒适体验。

而未来，我们会成为行业的标杆，我们会提供业内顶尖的优质型材及五金配件，我们的品牌会成为品质的代名词，我们会把服务做到无可挑剔，我们的产品会走进千家万户。我们希望，我们的品牌有一天会成为所有同行都想要超越的目标。

CONTENTS

目录



10-25 铝框玻璃柜系列
Aluminum frame glass cupboard series

26-29 拼接大板柜系统
Splicing large panel cabinet system

30-31 焊接大板柜系统
Splicing large panel cabinet system

32-35 立柱系统
Column system

36-45 开放式衣帽间系列
Open cloakroom series

46-55 铝木开放式衣帽间系列
Open cloakroom series

56-59 开放式收纳系列
Open storage series

60-63 博古架系列
Curio shelf series

64-73 玻璃门系统
Glass door system

74-87 功能层板系统
Function Laminate system

88-89 衣通杆系统
Clothes rod system

90-97 酒杯 / 酒瓶架系统
Wine glass/bottle rack system

98-109 移门系列
Sliding door series

110-127 生态门系列
Ecological door series

128-129 斜边屏风系列
Hypotenuse screen

130-144 板式通体长拉手系列
Plate type whole body long handle series

145-149 暗装拉手系列
Concealed handle series

150-163 板式衣柜门明装拉手系列
Plate wardrobe door handles with screws series

164-169 免拉手系列
Handle-free series

170-173 踢脚线系列
Skirting board series

174-175 拉直器系列
Straightener series

176-221 其他型材系列
Other profile series

Glass Cabinet

铝框玻璃柜系列

【格物】

设计理念：

尊于“自然至上”

格物致知，

品格于自身，写意无穷

怡情于物，吸收物的姿态于自我。

“欲诚其意者，先致其知，致知在格物”

铝框玻璃柜系列 - 餐边柜



产品组合明细 - 餐边柜

K3218 左右框前料

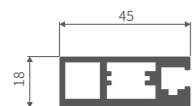

K3219 左右框后料

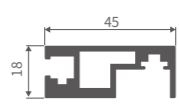

K3221 左右框上下料

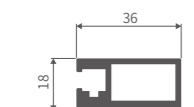

K3314 上下前横梁

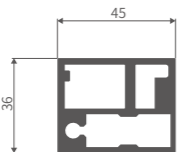

K3212 上下后横梁

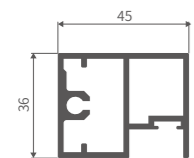

K3222 L型铝条

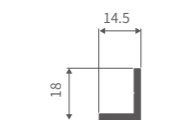

K3213 玻璃转换条

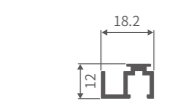

K3211 横梁连接件

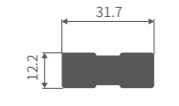

K3220 18侧框连接件

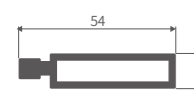

K3233 酒格层板滑块

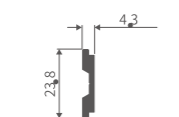

K3234 酒格层板圆管

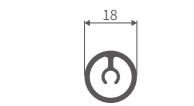

K3235 包边玻璃层板前灯

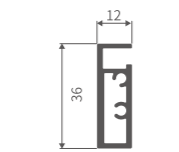

序号	名称	说明
1	左右框前料	K3218
2	左右框后料	K3219
3	左右框上下料	K3221
4	上下前横梁	K3314
5	上下后横梁	K3212
6	前后L型铝条	K3222
7	左右L型铝条	K3222
8	上下玻璃转换条	K3213
9	左右玻璃转换条	K3213
10	横梁连接件	K3211
11	18侧框连接件	K3220
12	5MM左右侧玻璃	
13	5MM背玻璃	
14	18MM顶底木板	
15	36MM玻璃层板 (选装)	
16	顶部玻璃可选配岩板	
17	玻璃胶条	
18	平头十字/内六角M4*8	
19	平头十字/内六角M4*12	
20	平头自攻ST4*16	
21	内六角圆柱头螺钉M5*18	
22	紧定螺丝内六角凹端 M6*30	
23	底座-左脚	
24	底座-垫条左右5X24X1000	
25	底座-垫条前后5X24X420	
26	底座-右脚	
27	平头内六角M6X12	

K3236 包边玻璃层板侧框

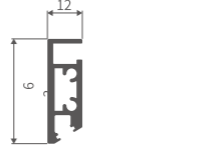



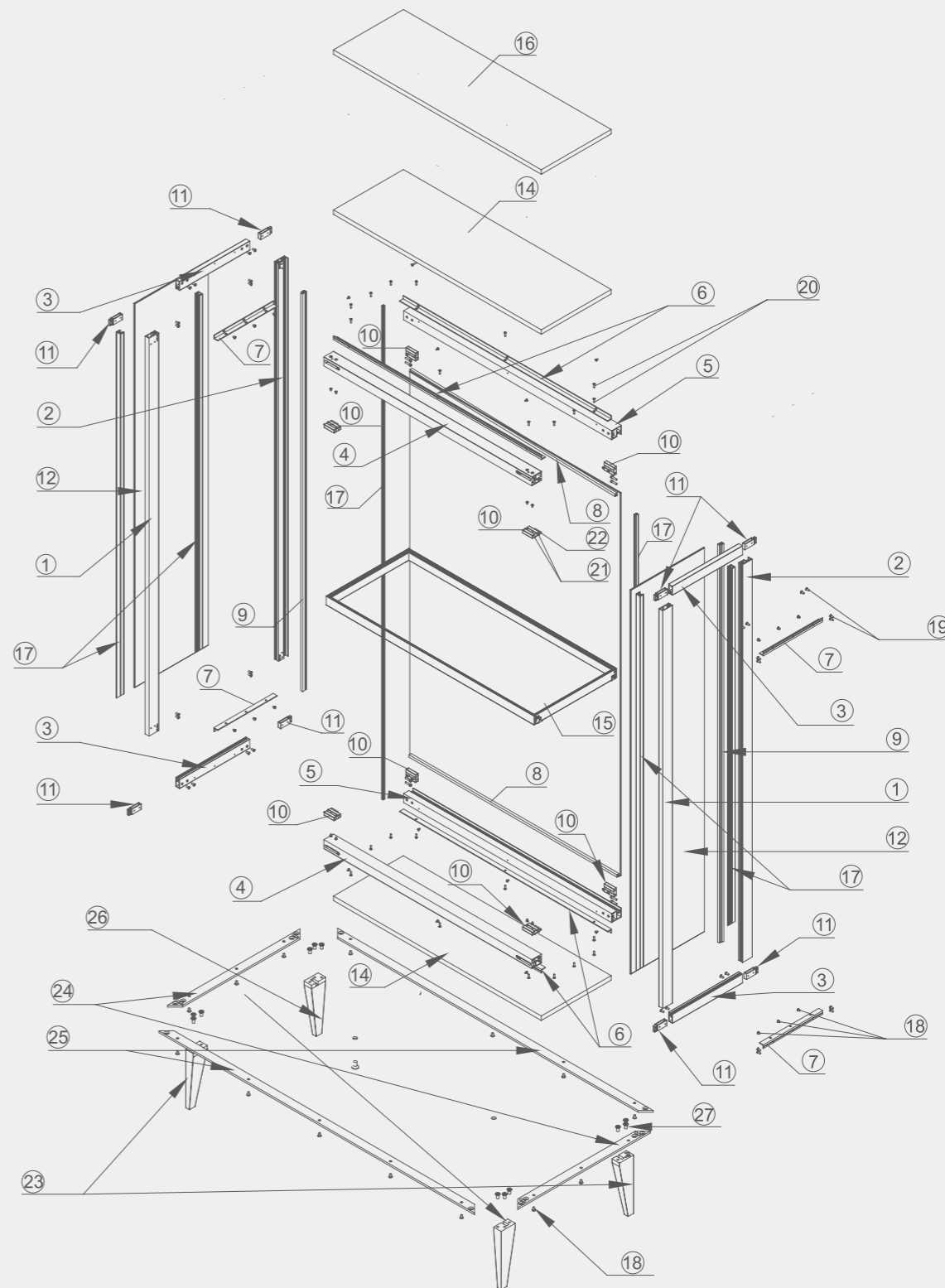



























产品安装方法

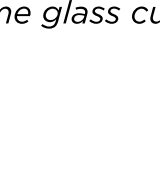

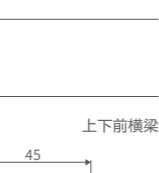

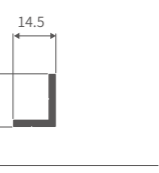
产品组合明细 - 酒柜

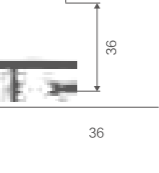
序号	名称	说明
1	左右框前料	 K3218
2	左右框后料	 K3219
3	左右框上下料	 K3221
4	上下前横梁	 K3314
5	上下后横梁	 K3212
6	前后L型铝条	 K3222
7	左右L型铝条	 K3222
8	上下玻璃转换条	 K3213
9	左右玻璃转换条	 K3213
10	横梁连接件	 K3211
11	18侧框连接件	 K3220
12	5MM左右侧玻璃	
13	5MM背玻璃	
14	18MM顶底木板	
15	36MM玻璃层板 (选装)	
16	36MM酒格层板 (选装)	
17	36MM杯挂层板 (选装)	
18	玻璃胶条	
19	平头十字/内六角M4*8	
20	平头十字/内六角M4*12	
21	平头自攻ST4*16	
22	内六角圆柱头螺钉M5*18	
23	紧定螺丝内六角凹端M6*30	

K3218 左右框前料 	K3219 左右框后料 
K3221 左右框上下料 	K3314 上下前横梁 
K3212 上下后横梁 	K3222 L型铝条 
K3213 玻璃转换条 	K3211 横梁连接件 
K3220 18侧框连接件 	K3214(A32-10) 前中柱(铰链位) 
K3216 中横(选配) 	K3215 后中柱(选配)
K3214(A32-10) 前中柱(铰链位) 	K3224 玻璃隔条(选配)
K3225 带灯地台线(选配) 	

产品安装方法

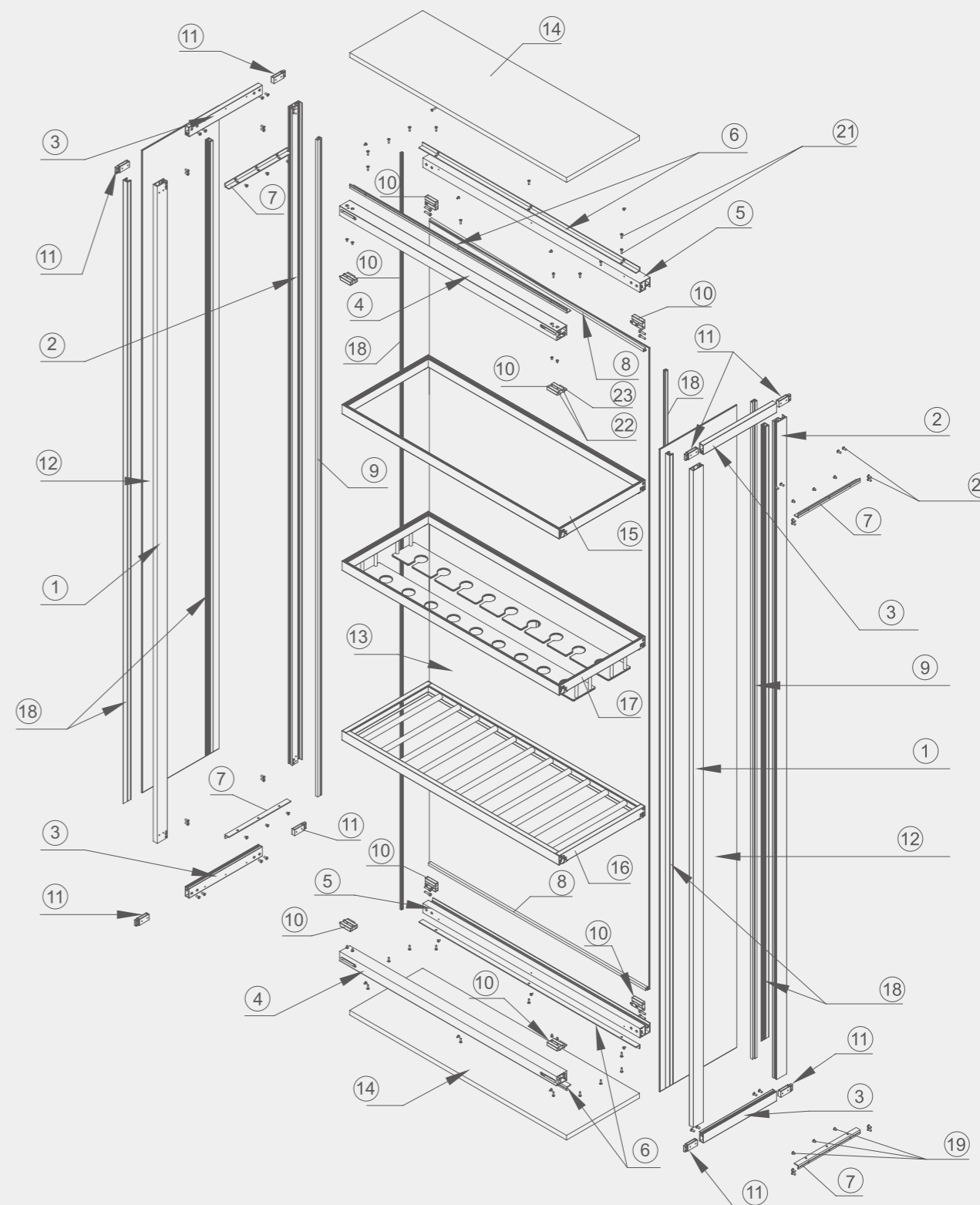



产品组合明细 - 吊柜

序号	名称	说明
1	左右框前料	 K3218
2	左右框后料	 K3219
3	左右框上下料	 K3221
4	上下前横梁	 K3314
5	上下后横梁	 K3212
6	前后L型铝条	 K3222
7	左右L型铝条	 K3222
8	上下玻璃转换条	 K3213
9	左右玻璃转换条	 K3213
10	横梁连接件	 K3211
11	18侧框连接件	 K3220
12	5MM左右侧玻璃	
13	5MM背玻璃	
14	18MM顶底木板	
15	36MM玻璃层板 (选装)	

序号	名称	说明
16	顶部玻璃可选配岩板	
17	玻璃胶条	
18	平头十字/内六角M4*8	
19	平头十字/内六角M4*12	
20	平头自攻ST4*16	
21	内六角圆柱头螺钉M5*18	
22	紧定螺丝内六角凹端M6*30	
23	挂柜挂件	
24	5mm底板	
25	5mm背板	
26	平头十字/内六角M5*6	
27	平头自攻ST4*32	

产品安装方法

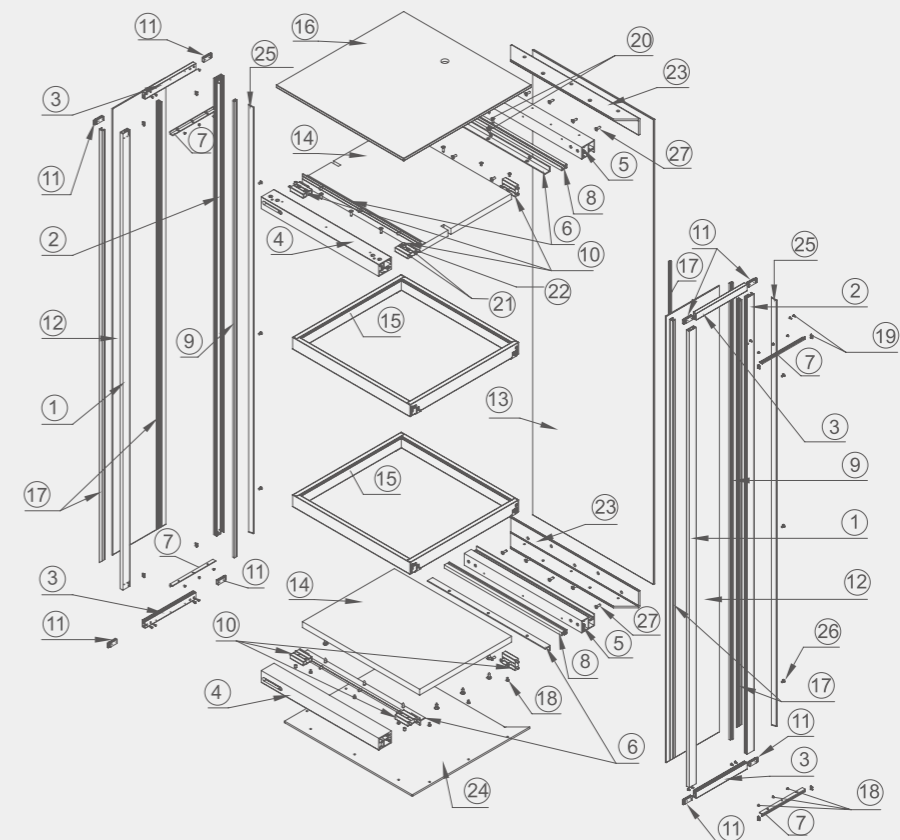





产品安装方法

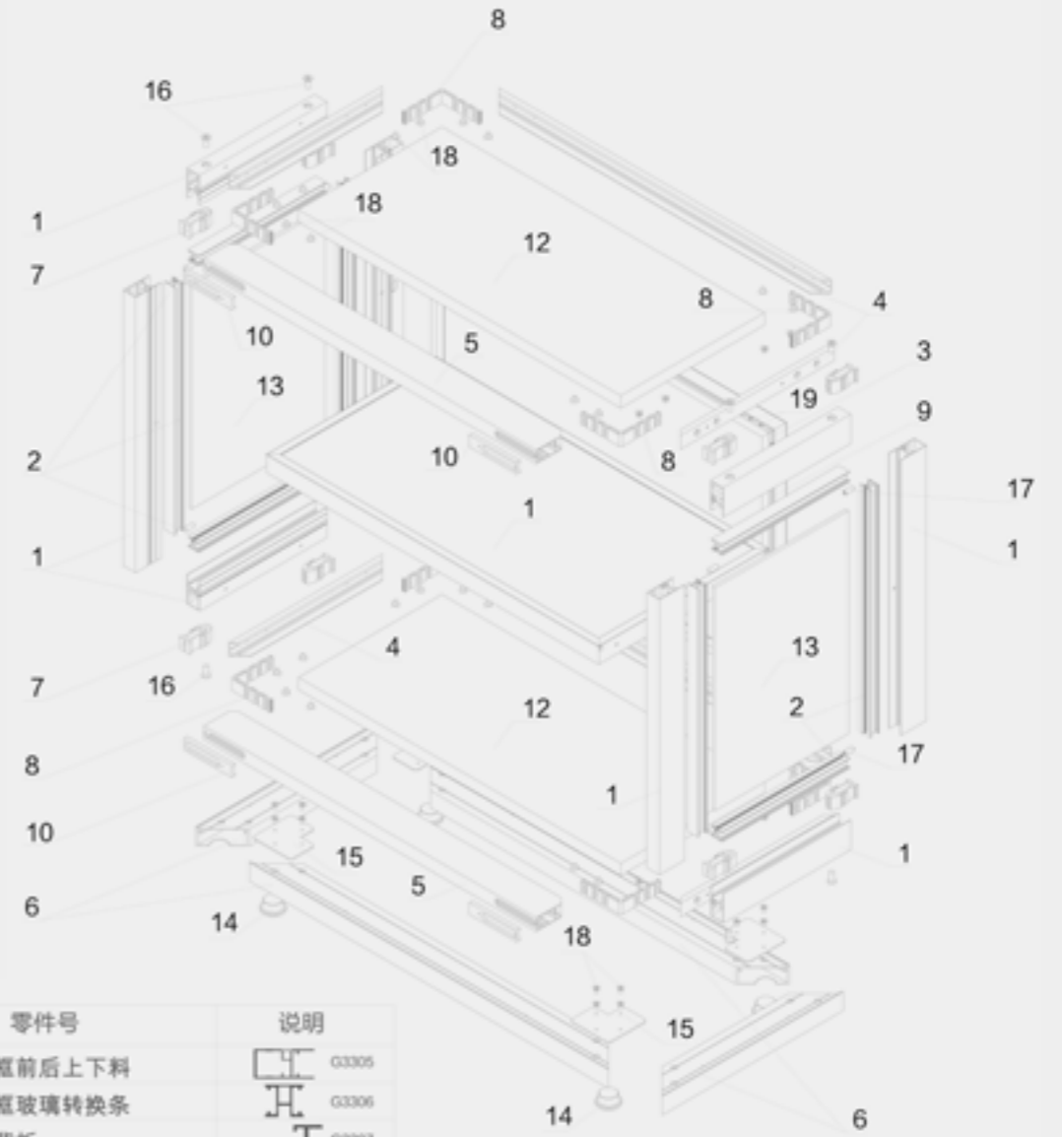

经济款玻璃柜

项目号	零件号	说明
1	侧框前后上下料	 G3305
2	侧框玻璃转换条	 G3306
3	后背板	 G3307
4	侧、后横梁	 G3308
5	天地横梁	 G3309
6	底座	 G3313
7	侧框角	 G3314
8	横底板角码	 G3315
9	后背板角码	 G3316
10	天地横梁插件	 G3317
11	玻璃层板框 (选配)	
12	顶底木板 (选配)	
13	侧框玻璃	
14	万向轮	
15	角码	
16	平头十字/内六角M6*12	
17	紧定螺丝内六角凹端M6*16	
18	平头十字/内六角M4*6	
19	紧定螺丝内六角凹端M4*4	

Large Panel Cabinet

拼接大板柜系统

【行界】





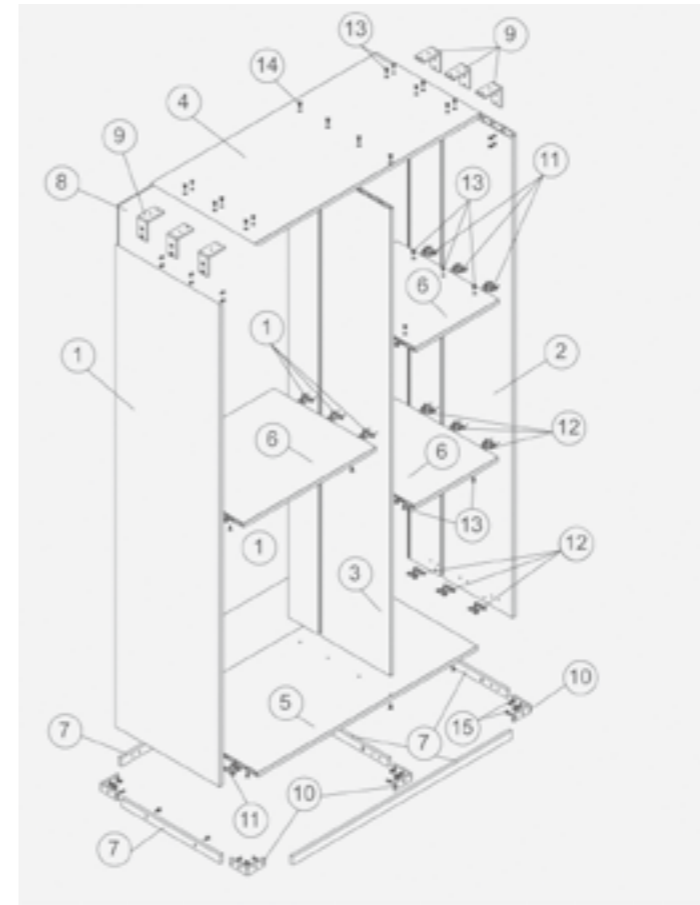



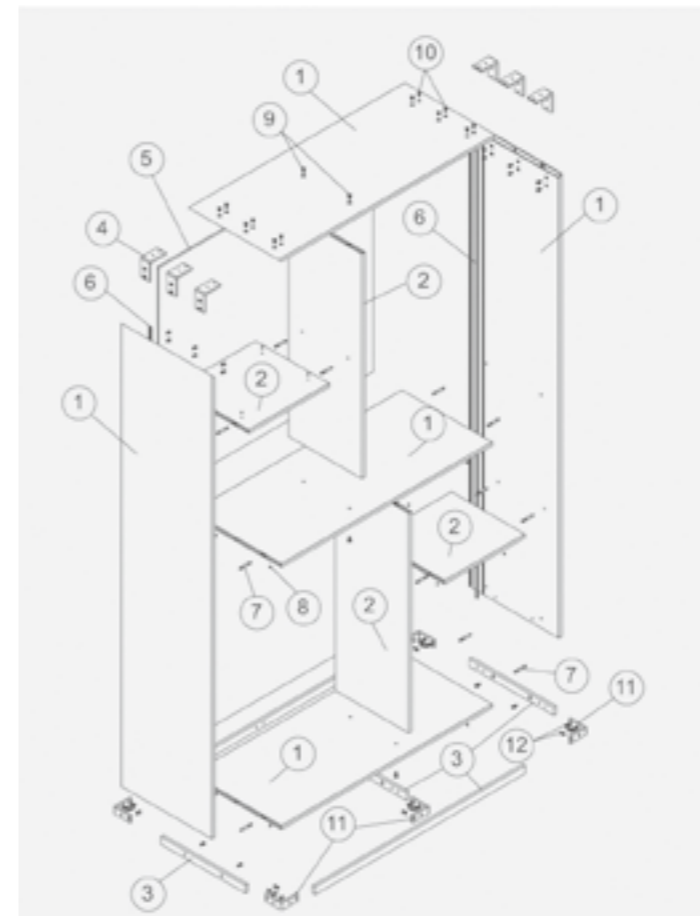



设计理念：

空亦为眼界
衍 - 缓缓的
引申为蔓延、扩展、富足
界 - 世界
生活的边界
缓缓的探索生活与自我的边界
让边界无界



序号	名称	图片
1	左侧板	 K3501
2	右侧板	 K3501
3	中竖板	 K3501
4	顶板	 K3501
5	底板	 K3501
6	中隔板	 K3501
7	20X8mm底座铝条	 K3502
8	4mm背板	 K3501
9	18X50X5.2mm连接角码	 K3501
10	28X50X5.2mm连接角码	 K3501
11	中隔板连接件	 K3501
12	M3X12mm沉头机丝	 K3501
13	M4X8mm沉头机丝	 K3501
14	M4X20mm沉头自攻	 K3501
15	内六角M4X12mm沉头机丝	 K3501



序号	名称	图片
1	270mm铝板	 K3503
2	220mm铝板	 K3504
3	20X8mm底座铝条	 K3502
4	28X50X5.2mm连接角码	 K3501
5	4mm背板	 K3501
6	灯盖	 K3501
7	M4螺杆	 K3501
8	M4x3mm顶丝	 K3501
9	M6X25mm小沉头自攻	 K3501
10	M4X5mm沉头机丝	 K3501
11	18X50X5.2mm连接角码	 K3501
12	内六角M4X10mm沉头机丝	 K3501

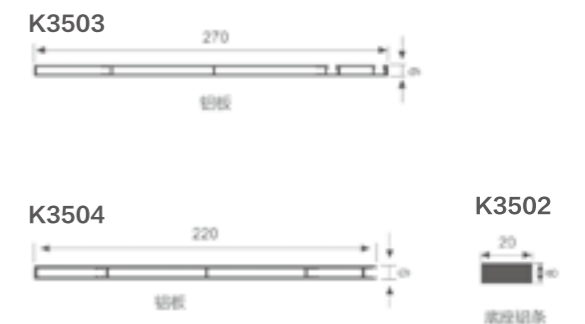

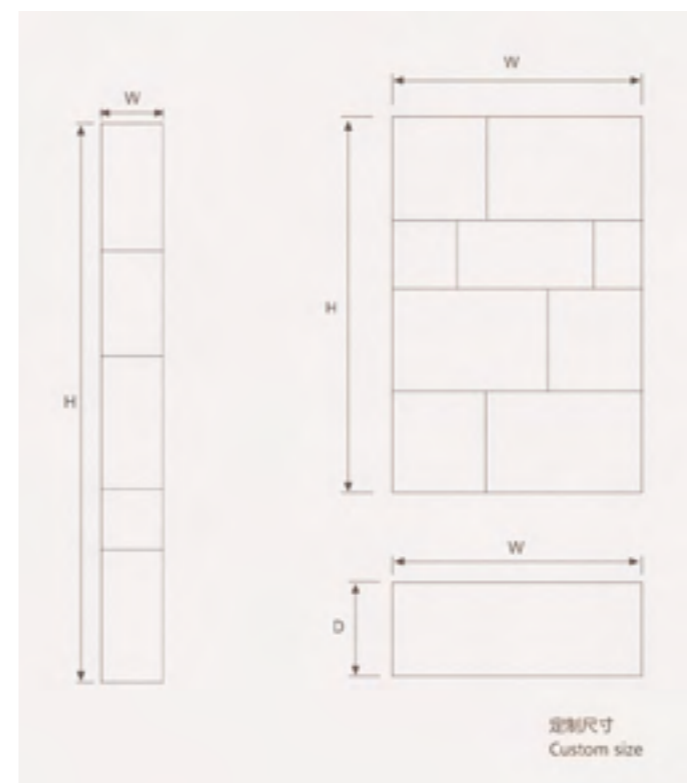

【轻奢极简焊接大板柜】

别具一格的造型设计、
高贵的色彩选择、
高级的选材与精良的制作工艺，
实为非凡卓越的经典之作。

Column System

立柱系统

〔光迹〕

设计理念：

光赋予空间以生命和灵魂，

勾勒着空间的边界与线条。

让抽象的空间被感知，随着光影看时光轨迹。

引领新的生活方式，设计空间以自然静谧生活为范本，

逃离尘嚣、回归本质。

Design concept:

Light endows space with life and soul,

Outlining the boundaries and lines of space.

Let the abstract space be perceived, along with the light and shadow to see the time trajectory.

Lead a new way of life, design space to natural quiet life as a model,

Escape from the dust, return to the essence.





产品组合明细 - 立柱系统

序号	名称	图片
1	立柱衣帽间底座	
2	立柱	
3	玻璃层板内滑块 (通用木层板)	
4	玻璃层板外滑块 (通用木层板)	
5	玻璃层板左右侧框 (通用斜层板)	
6	玻璃层板前框	
7	玻璃层板用玻璃	
8	斜层板内滑块	
9	斜层板外滑块	
10	斜层板前框	
11	斜层板中框	
12	斜层板玻璃	
13	斜层板后框 (通用玻璃层板, 通用铝木结合抽屉)	
14	抽屉内滑块	
15	抽屉外滑块	
16	铝木结合抽屉铝板 (包含左右侧板及顶板5mm厚)	
17	衣通内滑块	
18	衣通外滑块	
19	衣通座	
20	衣通杆	
21	木层板固定件	
22	M5X14内六角平头机丝	
23	M5X8十字平头机丝	
24	ST4X30十字自攻丝	
25	ST4X20十字自攻丝	
26	玻璃胶条	

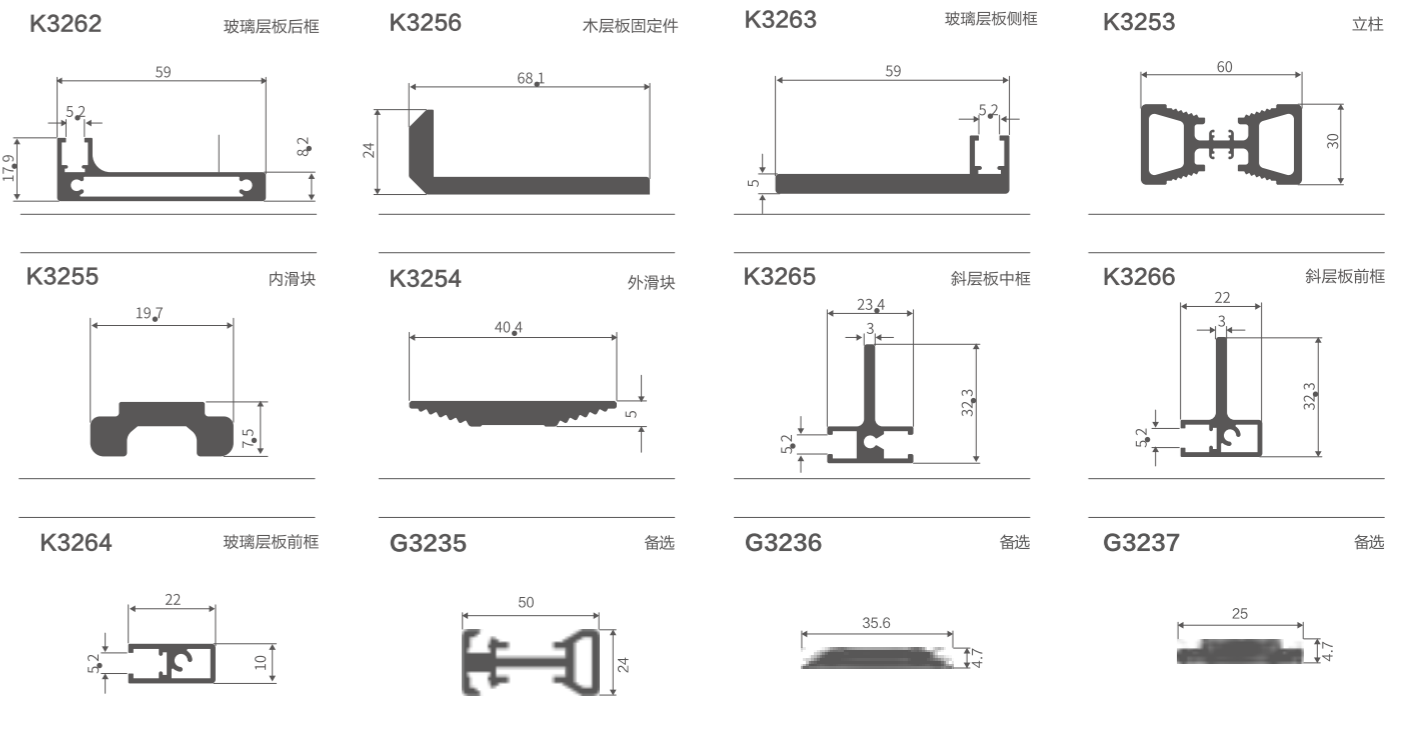
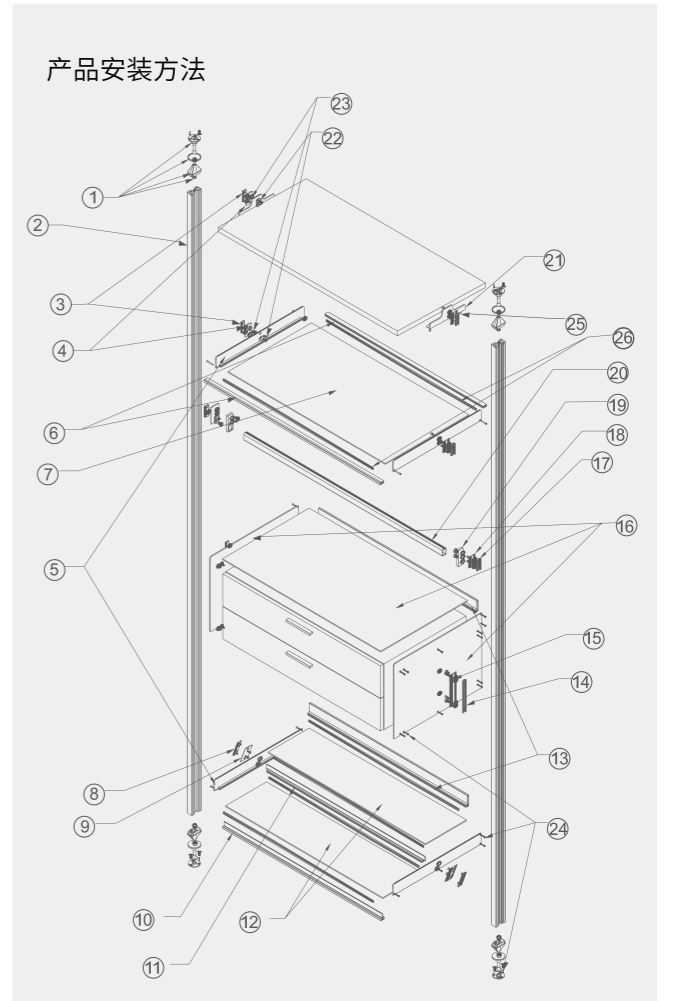

Open Cloakroom

开放式衣帽间系列

[雅纳]

理念:

自由、开阔、通透、协调的光线、精简流畅的线条，浑然天成的质感，打造出意式极简空间氛围。壁挂式衣橱是工业与艺术的完美邂逅，摒弃了侧板束缚的天马行空和自由，俨然成为当代衣帽间的新选择。

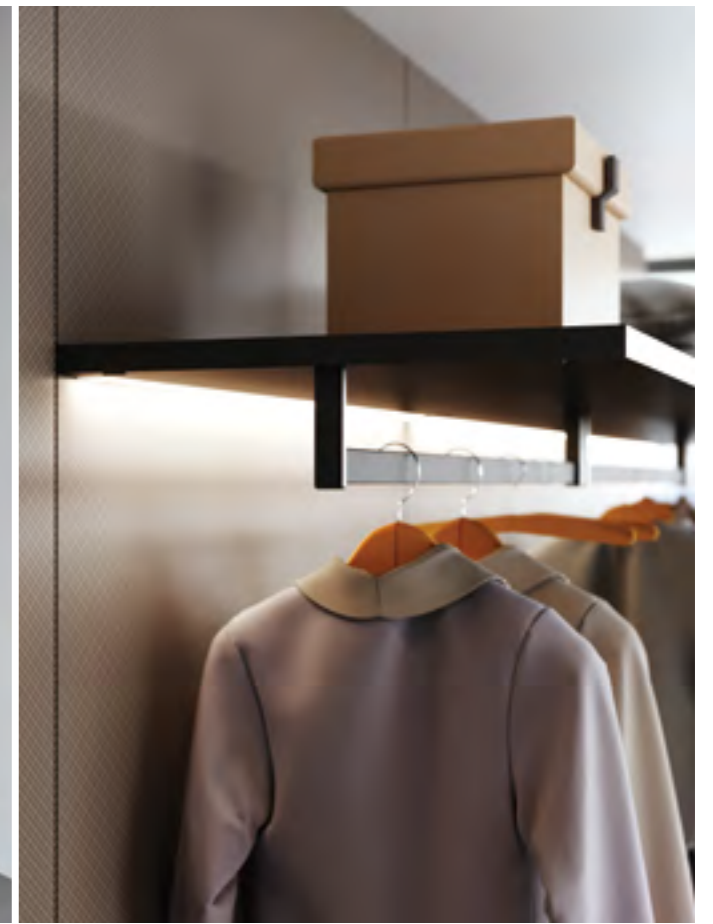



K3227 扣条



K3232 立柱

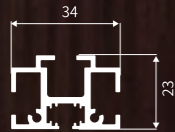

K3226 扣槽

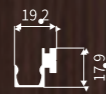

K3204 鞋中档



K3238 鞋前档



技术说明

全新可订制开放式衣帽间系统，三维调节

标准层板深度 500mm/400mm/300mm，厚度 25、35mm

标准侧板厚度 18mm 标准护墙板厚度 18mm

颜色：银白材质：铝合金



平面墙体固定件
每根铝材用 3-4 个固定件
材质：铁

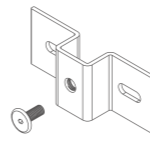

单边应用

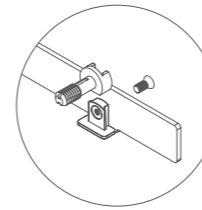

层板托

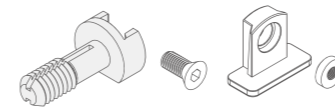

双边应用

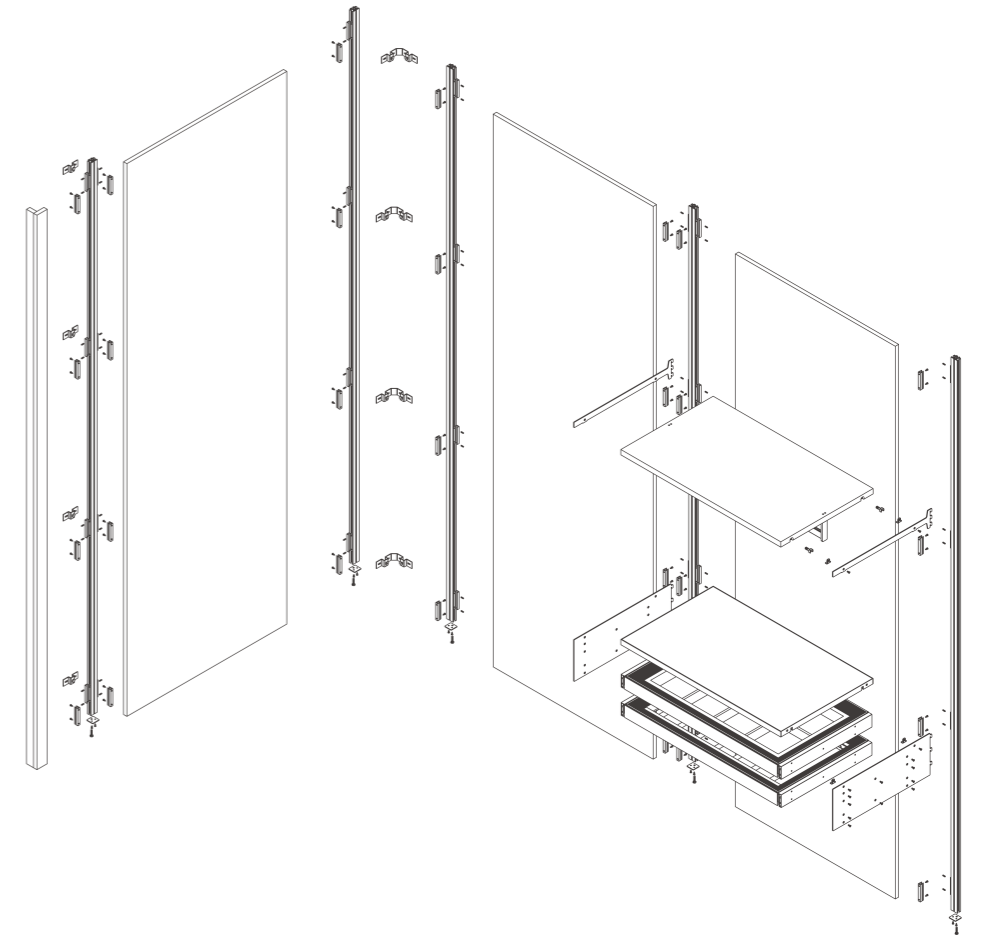
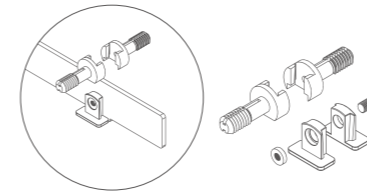

单柜子尺寸计算方法

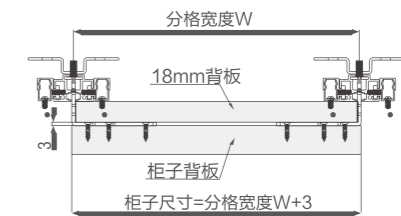

双柜子尺寸计算方法

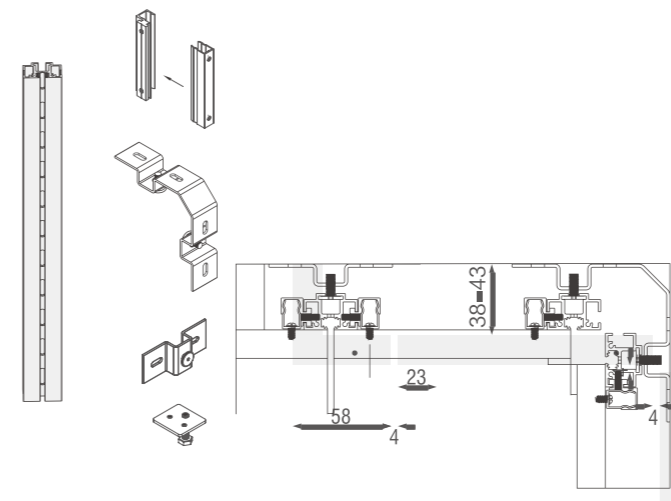
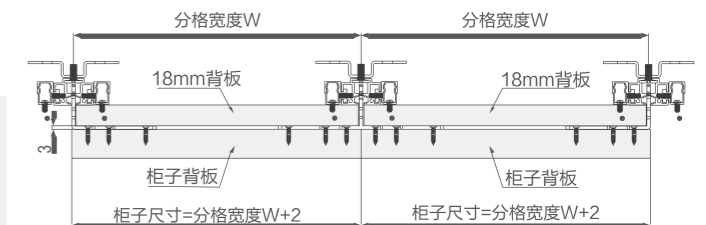

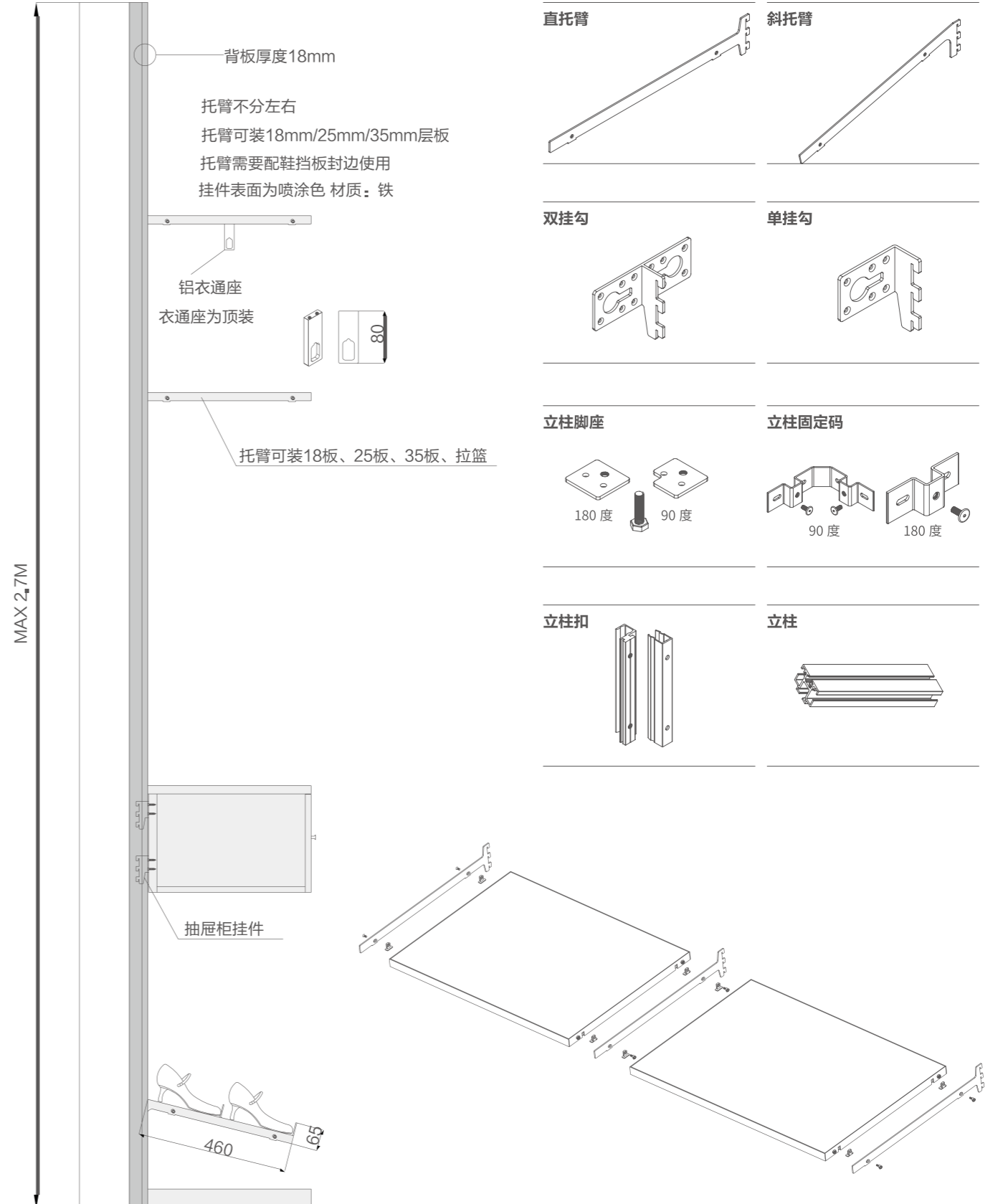
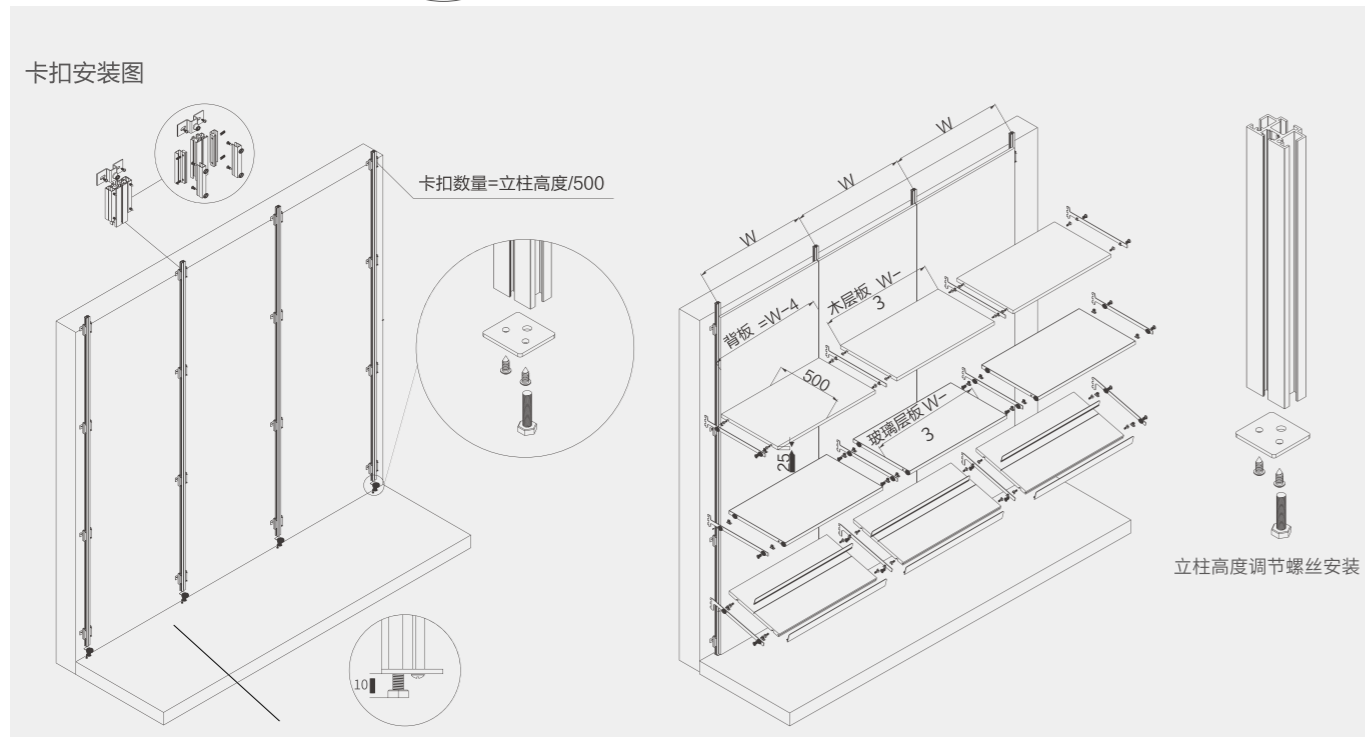
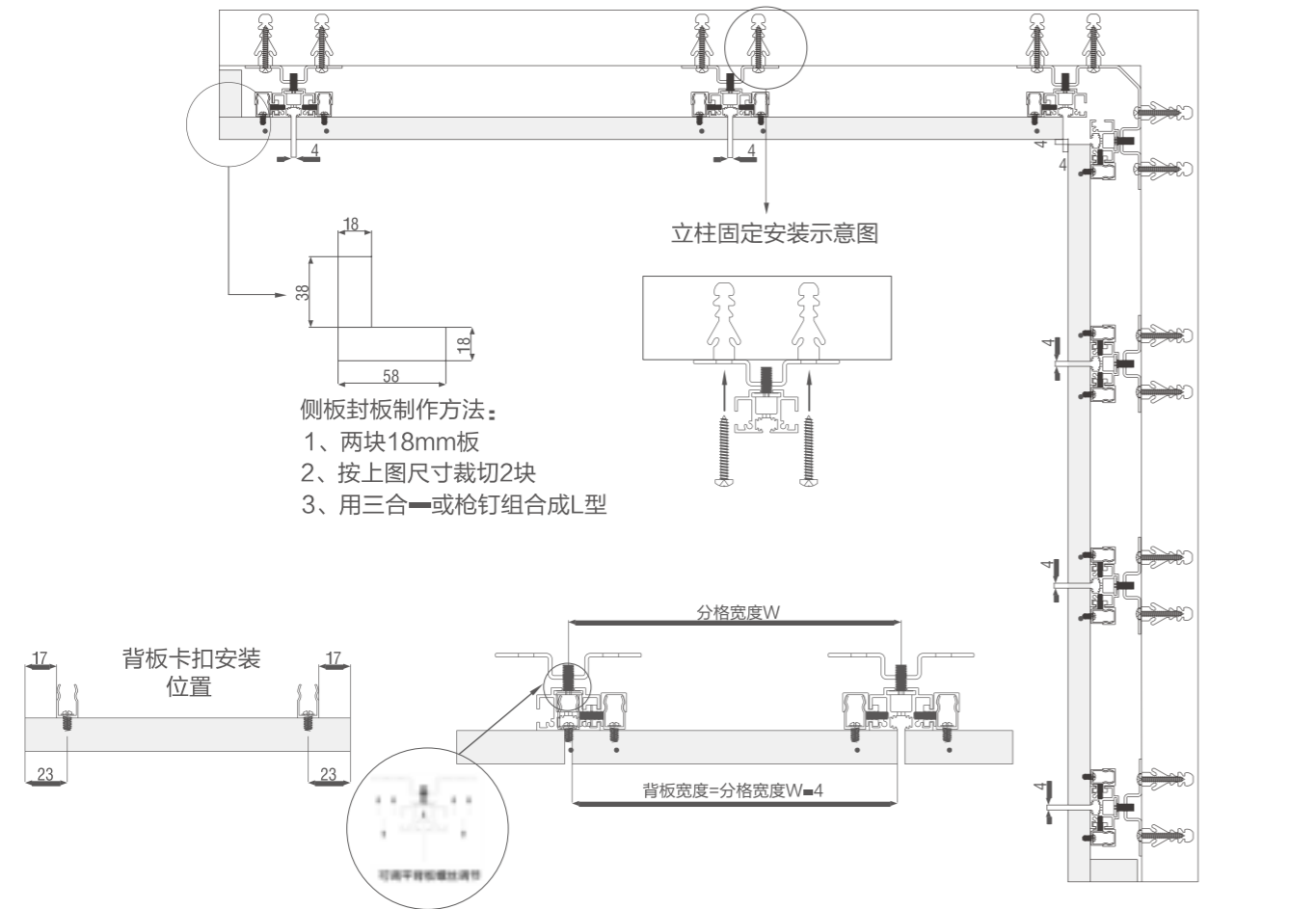

托臂式玻璃柜



G3321

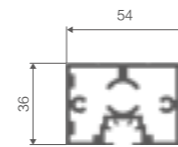

G3322

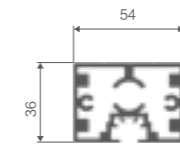

G3323

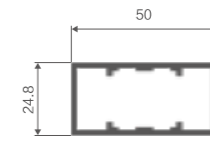

G3324

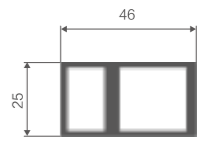

G3325

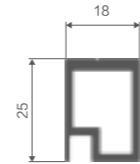

G3326

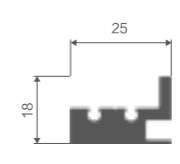

G3327

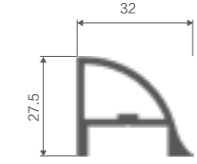

G3328

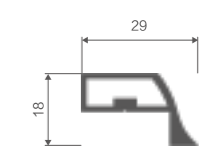

G3329

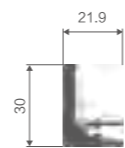

G3330

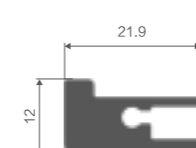

Open cloakroom

开放式衣帽间系列

【卡纳】

设计理念：

空间的开阔通透，协调的光线，精简流畅的线条，浑然天成的质感，打造出意式极简空间氛围。壁挂式衣橱是工业与艺术的完美邂逅，摒弃了侧板束缚的天马行空和自由，俨然成为当代衣帽间的新选择。







技术说明

K3271

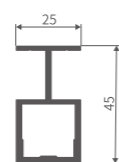

K3270

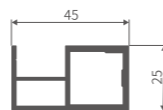

K3309

转角立柱 (选配)



序号	名称	说明
1	前框	 (3272)
2	后中框	 (3271)
3	后侧框	 (3270)
4	25mm连接管	 (3275)
5	侧板卡扣	 (3226)
6	顶木板=25mm带灯	 (3275)
7	底木板=25mm	 (3275)
8	25mm斜层板木板 (组件有独立爆炸图)	 (选配)
9	25mm板背板	 (选配)
10	裤架抽组件 (组件有独立爆炸图)	 (选配)
11	收纳组件 (组件有独立爆炸图)	 (选配)
12	抽屉	 (选配)
13	三合一连接件 (A)	 (3276)
14	三合一连接件 (B)	 (3276)
15	45度25层板含衣通 (组件有独立爆炸图)	 (选配)
16	45度25层板 (组件有独立爆炸图)	 (选配)
17	25方管连接件	 (3276)
18	抽屉挂件	 (选配)
19	M4*30十字机丝	 (3276)
20	M4*8内六角机丝	 (3276)
21	ST4*30自攻丝	 (3276)
22	M5*30十字机丝	 (3276)
23	左右侧板 (25mm)	 (3276)
24	后木板 (18mm)	 (3276)

K3275

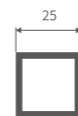

K3226

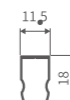

K3272

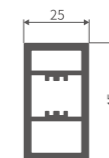

K3276

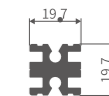

产品安装方法

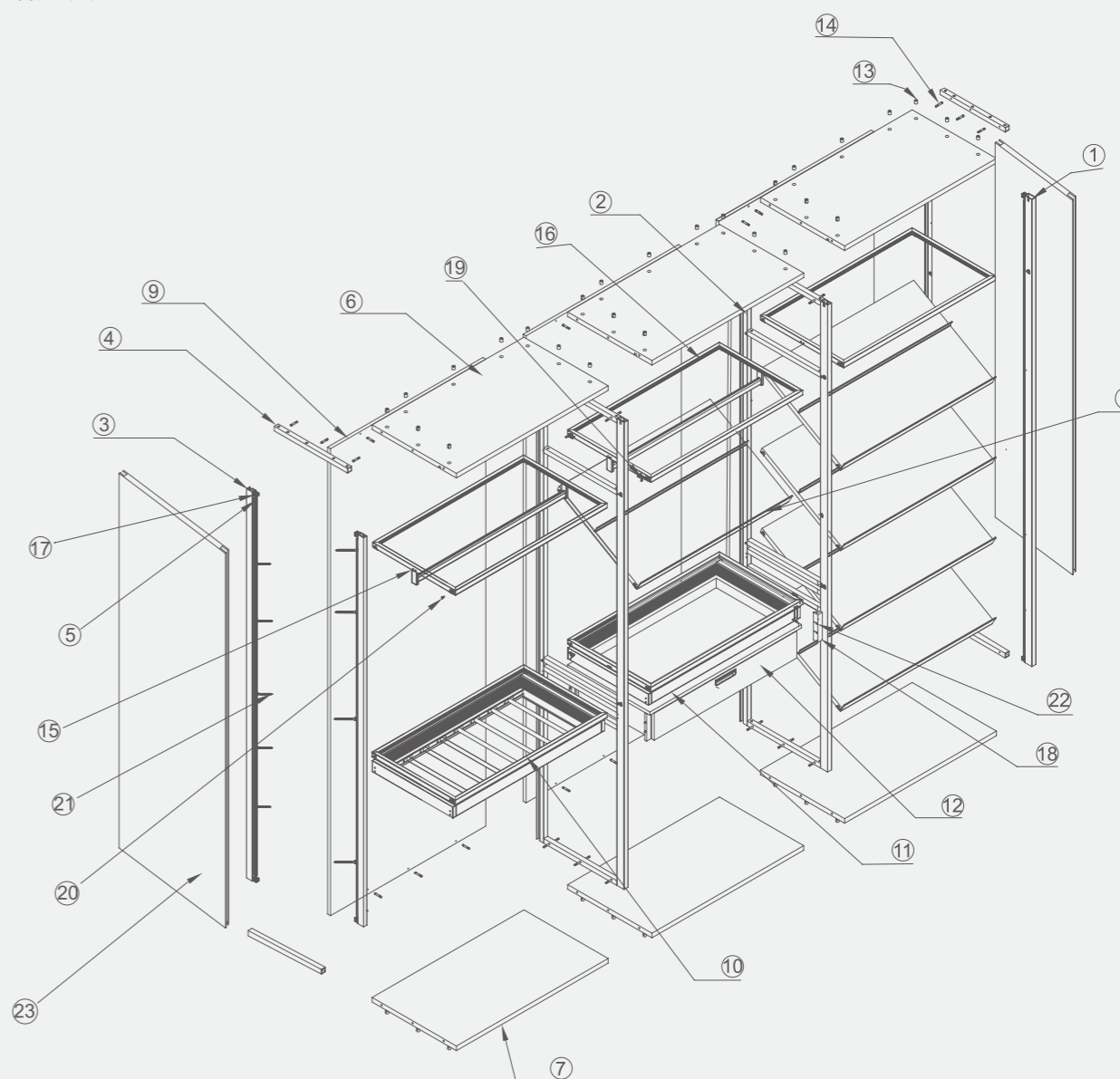

圆弧形岛台

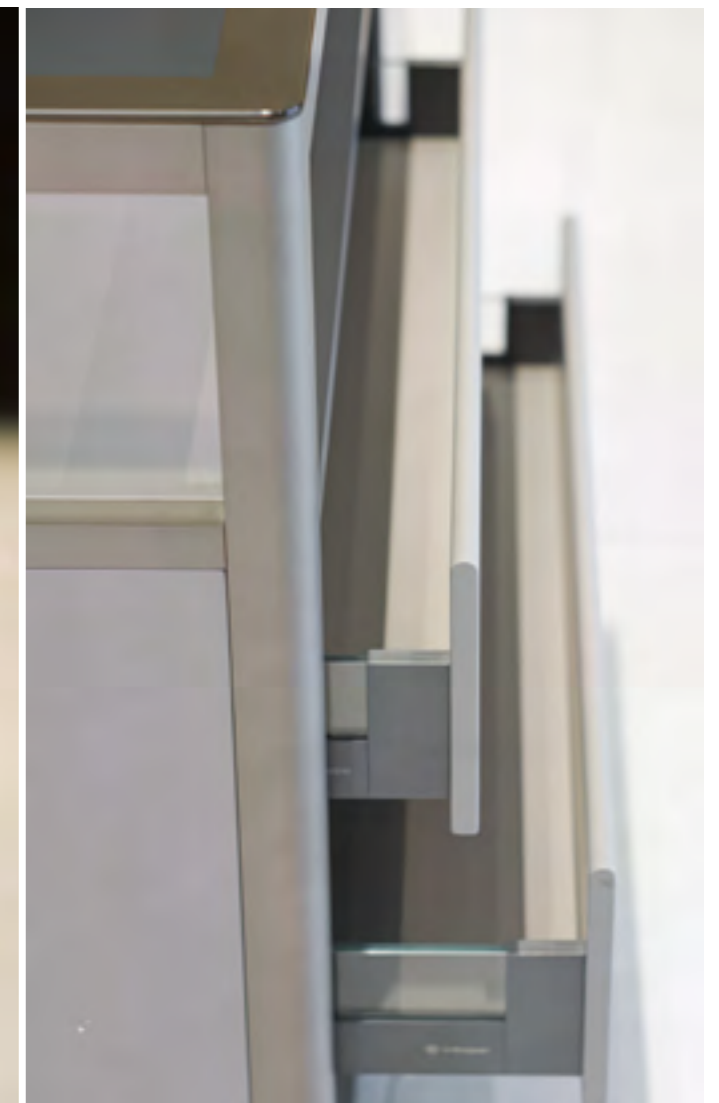

G3331

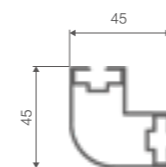

G3332

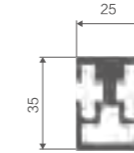

G3333

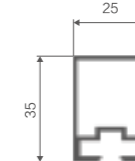

G3334

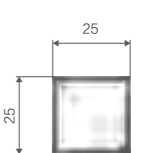

Open Storage

开放式收纳系列

[海纳]

设计理念：

海纳百川，有容乃大
开阔通透，光线协调
精简流畅的线条，浑然天成的质感
打造意式极简空间氛围
工业与艺术的完美邂逅



九宫格组合

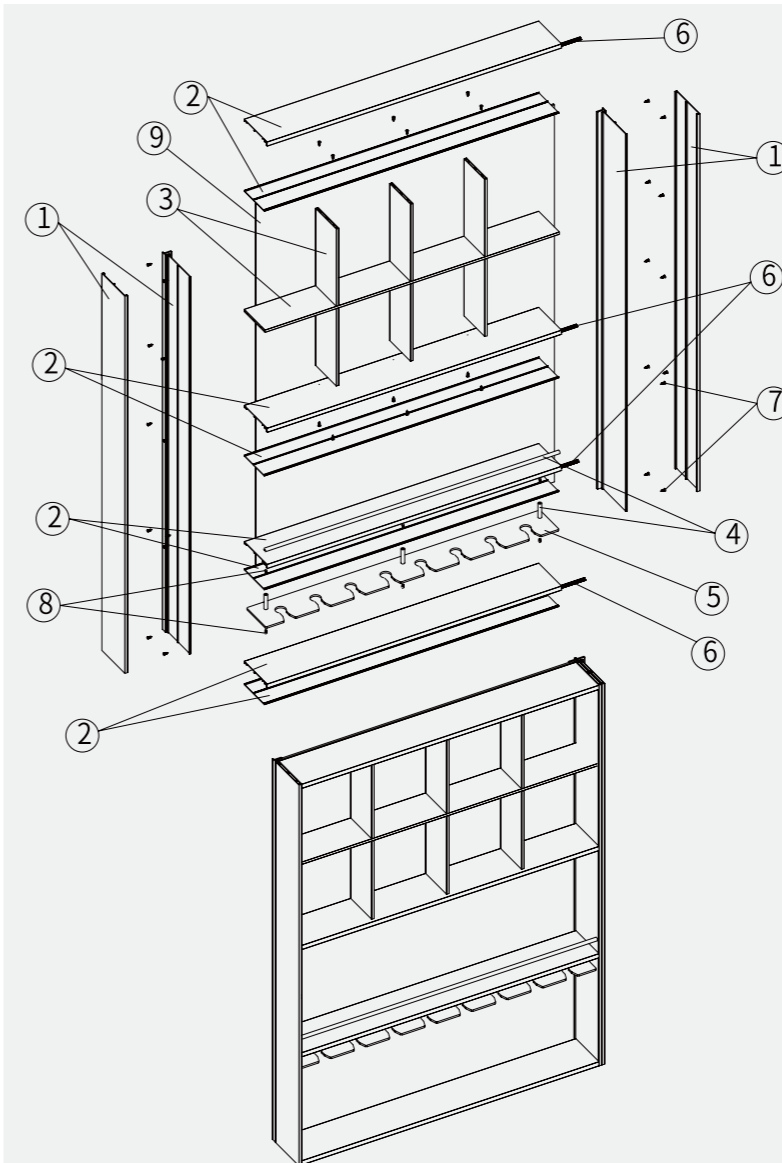
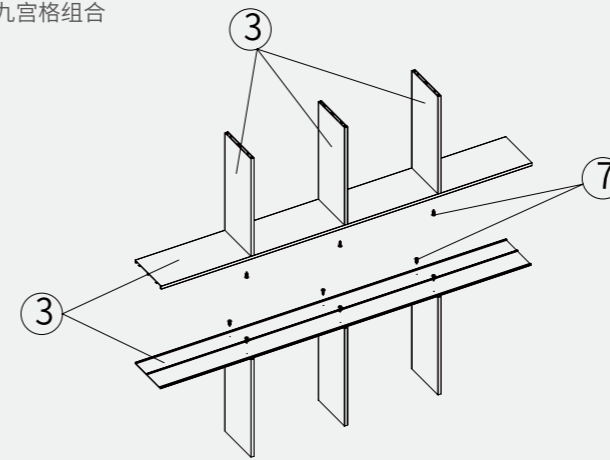

序号	名称	图片
1	左右竖板	
2	组合层板	
3	组合九宫格	
4	圆管	
5	酒杯架	
6	灯盖	
7	M3x12mm沉头自攻	
8	M4x12沉头自攻	
9	6mm背板/发光背板	

K3297/K3298 九宫格横竖板

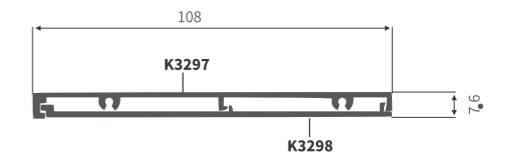

K3299 层板 (选配) 可替代②

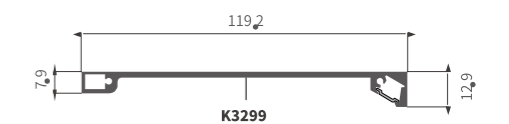

K3300/K3298 层板

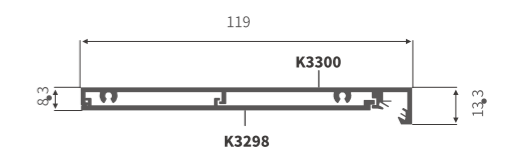

K3302/K3303 竖边板

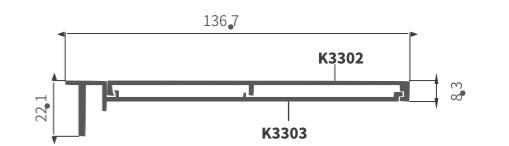

K3223 圆管





K3202
铝立柱 $\phi 11$



子弹头铝底座



铝卡扣 $\phi 12$

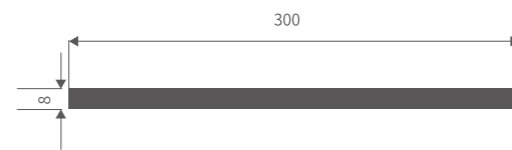

K3505



连接铝圆管



铝堵头



铝两通



铝三通



铝四通



铝法兰 A



铝法兰 B

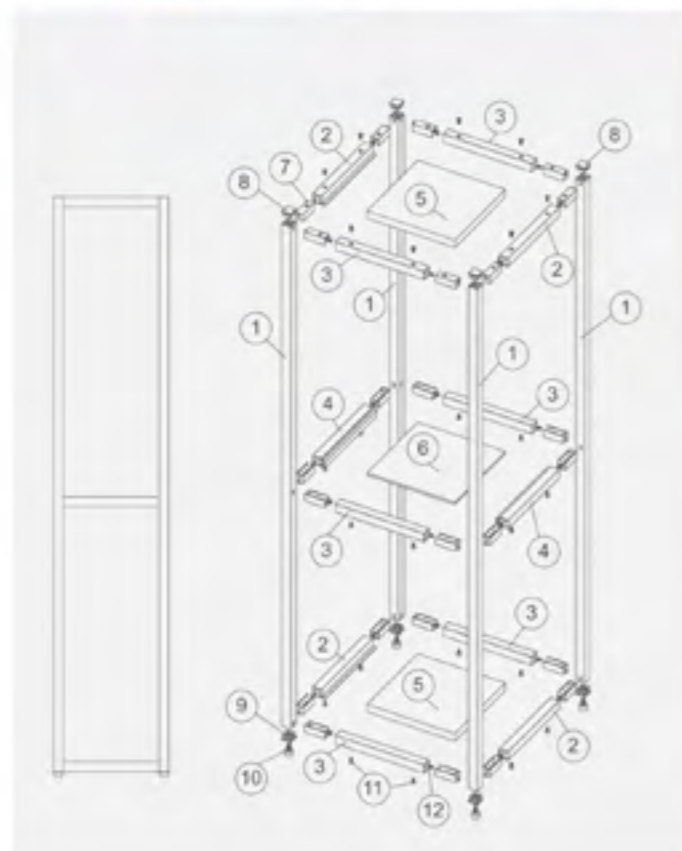

序号	名称	图片
1	立柱	K3126
2	木板横托	K3128
3	通用横管	K3127
4	玻璃横托	K3129
5	25mm层板	
6	5mm厚玻璃	
7	连接件	
8	顶部封堵	
9	底部封堵	
10	调节脚	
11	M4x10内六角沉头机丝	
12	M4x10圆头机丝	



Glass Door Series

玻璃门系列

【意式极简】

设计理念：

“意式极简”——以简单到极致为追求，

主张简洁外形和实用功能主义相结合。

讲究格调 打造细节

在空间延续寻共鸣



易简 -PT001

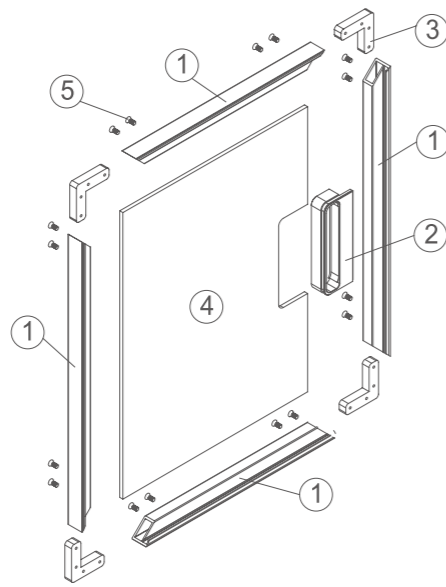

序号	名称	图片
1	门框料	
2	内嵌拉手	
3	连接角码	
4	5mm玻璃	
5	M4x10内六角沉头机丝	

K1601

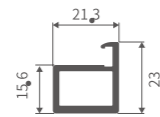

20 铰链



易简 -PT003

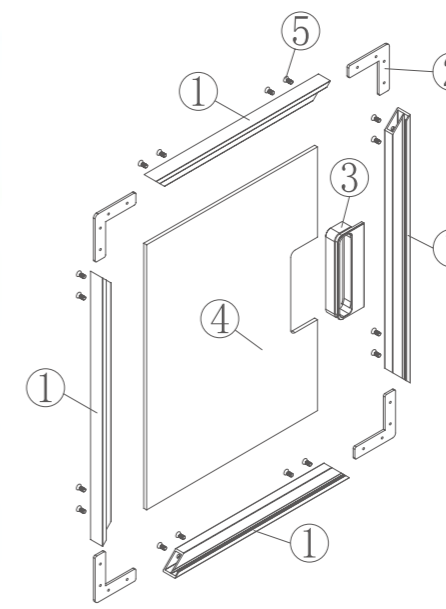

序号	名称	图片
1	门框料	
2	天地角码	
3	内嵌拉手	
4	5mm玻璃	
5	M4x10内六角沉头机丝	

20 铰链



K1536

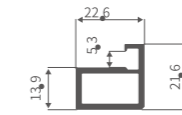

门框料

拉手 A、B、C 款均可定制 任意 20 框、天地框



拉手款式 A



拉手款式 B



拉手款式 C

易简 -PT002

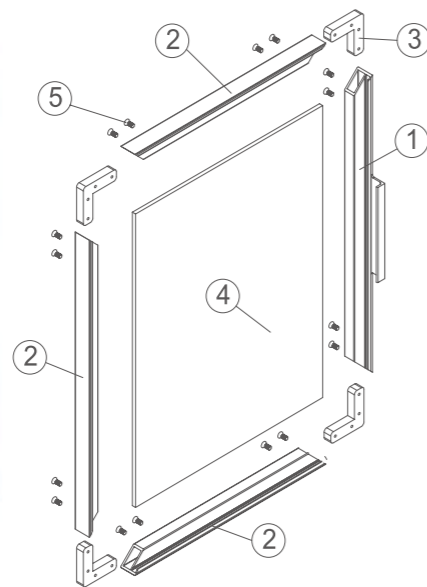

序号	名称	图片
1	门框料	
2	门框料	
3	连接角码	
4	5mm玻璃	
5	M4x10内六角沉头机丝	

K1601

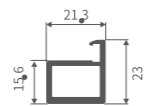

K1600

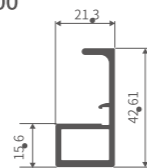

20 铰链



精简 -PJ001

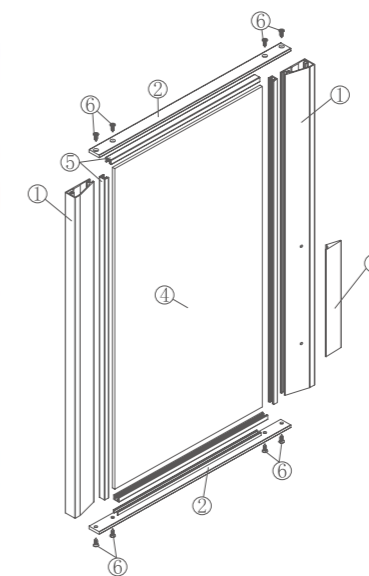

序号	名称	图片
1	门框料	
2	门框料	
3	拉手	
4	5mm玻璃	
5	玻璃胶条	
6	M5x25沉头自攻螺丝	

35 铰链



K2062

门框料

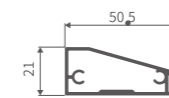

K2063

门框料

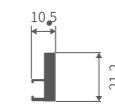

K1874

拉手

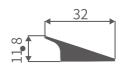

精简 -PJ003

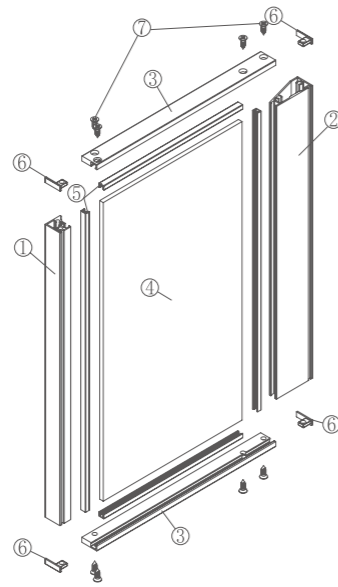

序号	名称	图片
1	门框料	K3509
2	门框料	K3511
3	门框料	K3510
4	5mm玻璃	
5	玻璃胶条	
6	封堵(分左右)	
7	M5x25沉头自攻螺丝	

35 铰链



K3509 门框料 K3511 门框料 K3510 门框料

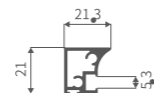
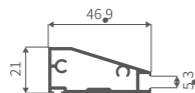

格致 -TD002

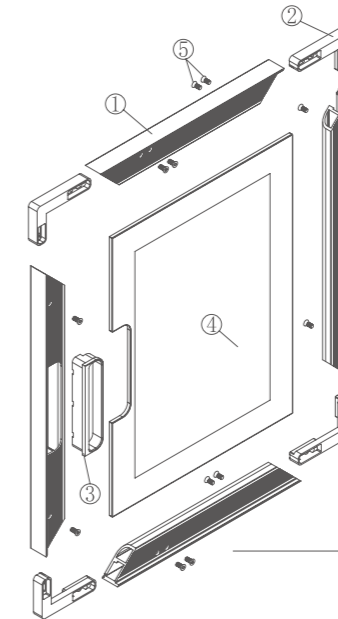

序号	名称	图片
1	门框料	K3514
2	天地角码	
3	内嵌拉手	
4	5mm油漆边玻璃	
5	M4x10内六角沉头机丝	

K3514 门框料 天地铰链

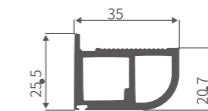

格致 -TD001

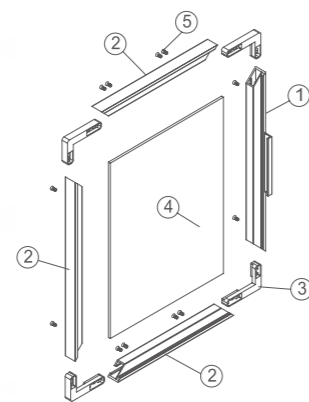

序号	名称	图片
1	门框料	K2082
2	门框料	K2080
3	天地角码	
4	5mm玻璃	
5	M4x16内六角沉头机丝	

K3268 18天地横梁(选配) K3269 横梁防坠件 K3062 18天地横梁(选配)

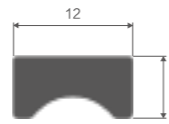
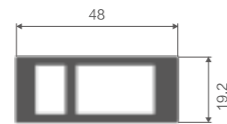

K2082

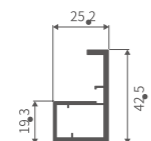

K2080

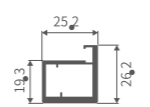

天地铰链



格致 -TD003

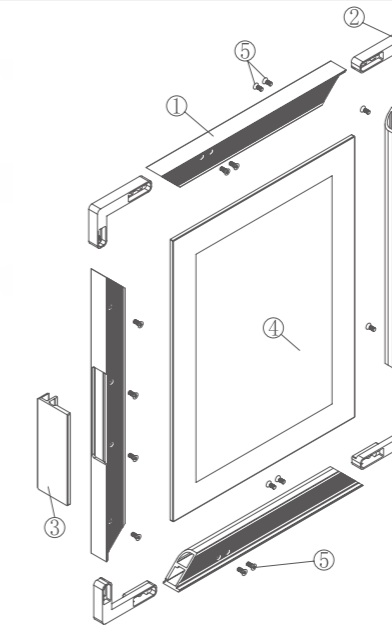

序号	名称	图片
1	门框料	K3514
2	天地角码	
3	内嵌拉手	
4	5mm油漆边玻璃	
5	M4x10内六角沉头机丝	

K3514 门框料 K3267 内嵌拉手(选配) 天地铰链

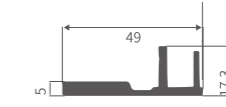
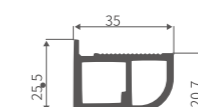

格致 -TD004

序号	名称	图片
1	门框料	K2093
2	门框料	K2094
3	连接角码	
4	5mm玻璃	
5	M4x10内六角沉头机丝	

K2093

K2094

天地铰链

格致 -TD006

序号	名称	图片
1	门框料	K2080
2	天地角码	
3	内嵌拉手	
4	5mm玻璃	
5	M4x16内六角沉头机丝	

K2080

天地铰链

拉手 A、B、C 款均可定制 任意 20 框、天地框

拉手款式 A

拉手款式 B

拉手款式 C

格致 -TD005

序号	名称	图片
1	门框料	K3310
2	门框料	K3311
3	圆管拉手	K3312
4	重型天地角码	
5	格条套芯	
6	5mm玻璃	
7	M4x16内六角沉头机丝	

K3269 横梁防坠件

G3170/K3585

G3169/K3584

K3063 25天地横梁 (选配)

K3311 门框料

A32-18(K3313) 25天地横梁 (选配)

K3310 门框料

K3312 格条

重型天地铰链

格致 -TD007

项目号	零件号	说明
1	门框料	
2	门框料拉手	
3	门框玻璃	
4	天地角码	
5	平头十字内六角M4*12	

G3302 门框料拉手

G3304 门框料拉手

G3301 门框料

G3318 门框料拉手

天地铰链

至臻 -ZS001

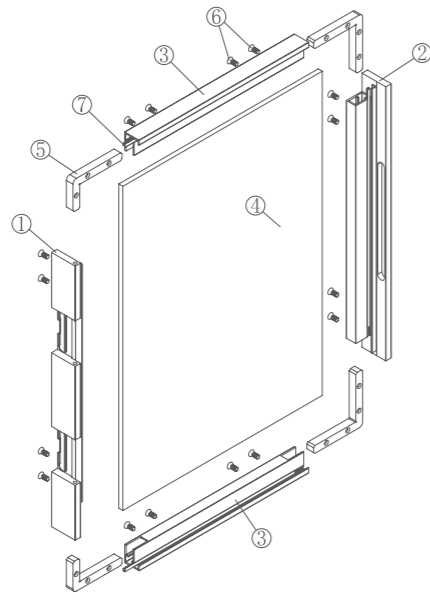

序号	名称	图片
1	门框料	K2144
2	门框料	K2145
3	门框料	K2143
4	5mm玻璃	
5	角码	
6	M4x10内六角沉头机丝	
7	玻璃胶条	

针式铰链

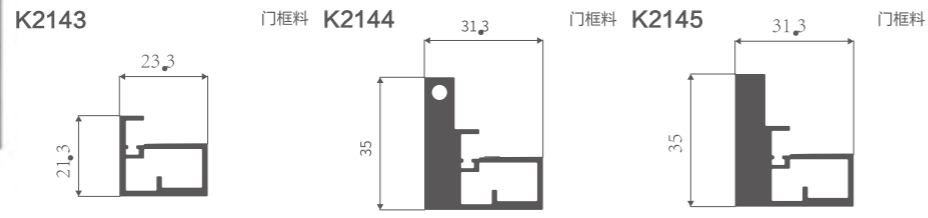

至臻 -ZS002

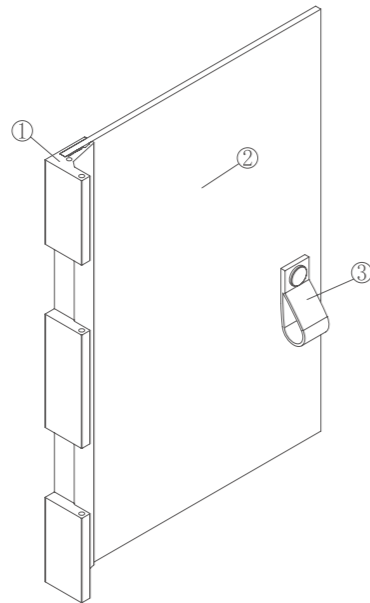

序号	名称	图片
1	边框料	K3515
2	5mm玻璃	
3	玻璃扣	

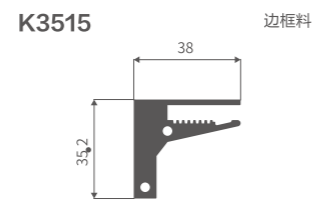

针式铰链



至臻 -ZS003

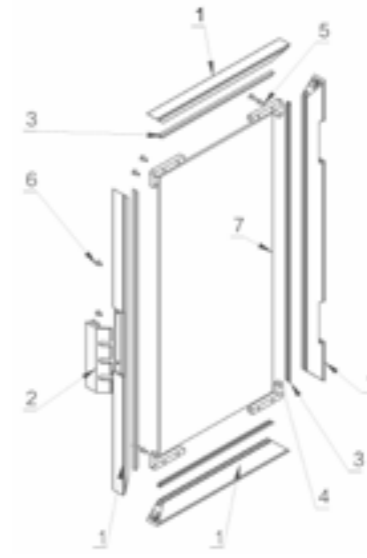

序号	名称	图片
1	门框	G3289
2	拉手	G3290
3	门框门扇胶条	
4	针式铰链角码	
5	针式铰链角码-螺丝	M4x10
6	拉手-螺丝	M4x10
7	门扇玻璃	

G3289 门框料

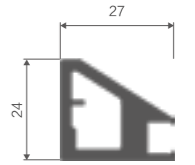

G3290 拉手

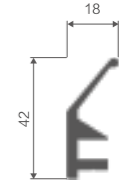

针式铰链



臻品 -PC002



K2150 门框料

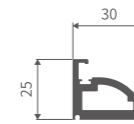

K2152 门框料

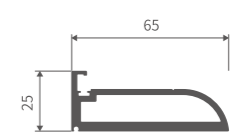

K3304 圆管拉手



K2177 内嵌拉手(选配)

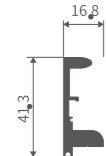

跑车铰链



Functional Laminate series

功能层板系统 —

【功能和美学完美共生】

设计理念：

现代设计产生以来占主导地位的功能论设计美学认为：
功能本身可以成为一种美，依照功能的需求而设计的产品形式，
可以成为美的形式，
设计在追求功能美的基础上也在追求精神需求，
以此获得现代设计美学中功能美的价值意义，
倡导人们关注设计功能



铝框玻璃层板 CB-B001

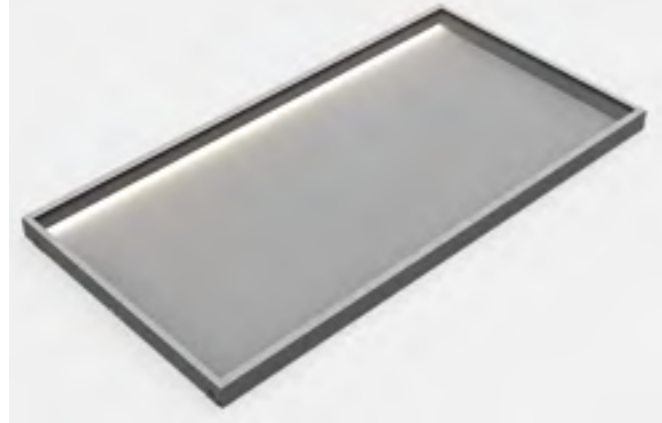

K3228

隐边玻璃层板前灯

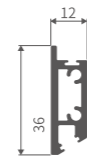

K3229

隐边玻璃层板侧框

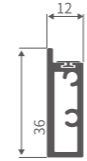

序号	名称	图片
1	左侧框（导电）衣柜	K3229
2	前灯衣柜	K3228
3	后框衣柜	K3229
4	右侧框（导电）衣柜	K3229
5	玻璃柜层板衣通座	K1199
6	衣通杆	K328
7	木层板托-锌合金	
8	层板触点	
9	十字平头自攻螺丝ST4.2X32	
10	平头内六角M4X8	
11	玻璃	
12	P083（宽）	
13	P083（深）	
14	平头内六角M4X8	
15	灯盖	

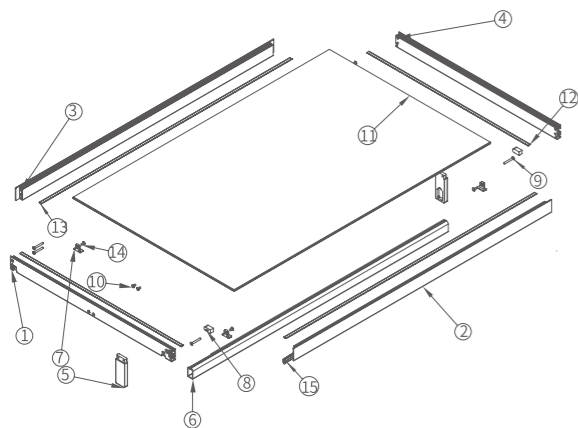

铝框玻璃层板 CB-B002

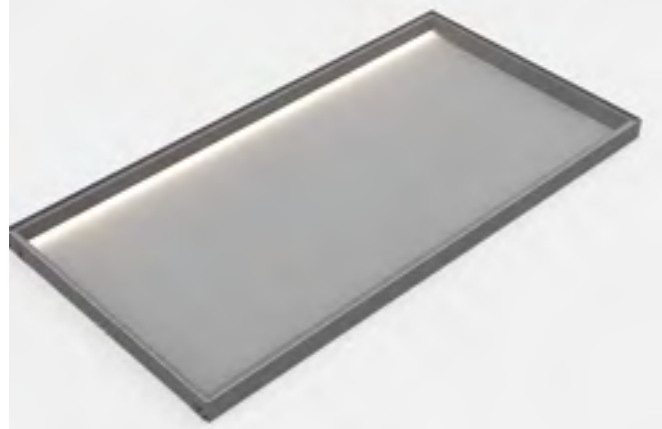

K3235

包边玻璃层板前灯



K3236

包边玻璃层板侧框



序号	名称	图片
1	包边左侧框（导电）	K3235
2	包边后框	K3235
3	包边右侧框（导电）	K3235
4	包边前灯	K3236
5	木层板托-锌合金	
6	层板触点	导电连接头
7	十字平头4X32	
8	平头内六角M4X8	
9	5mm玻璃	
10	灯盖	

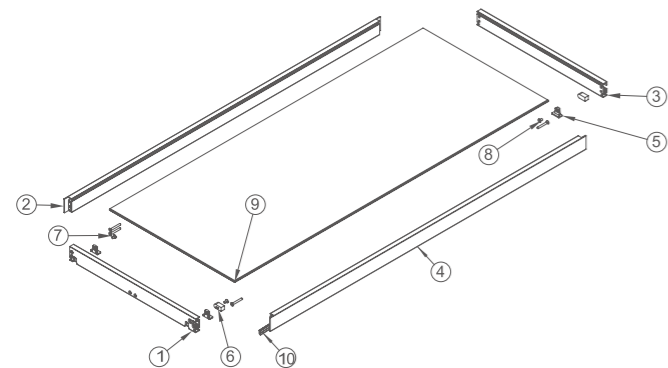

铝框玻璃层板 CB-B003

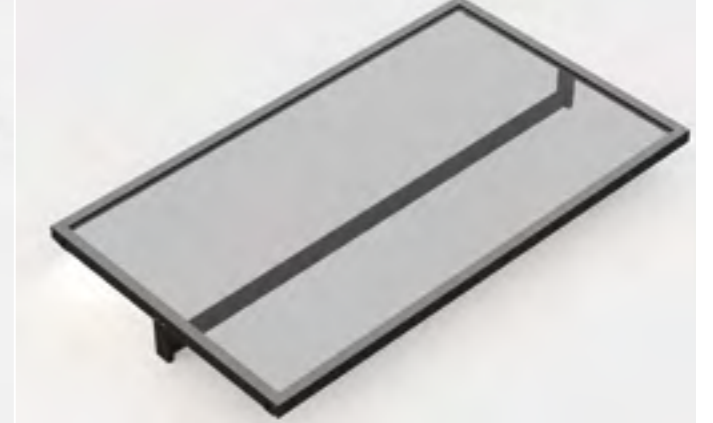
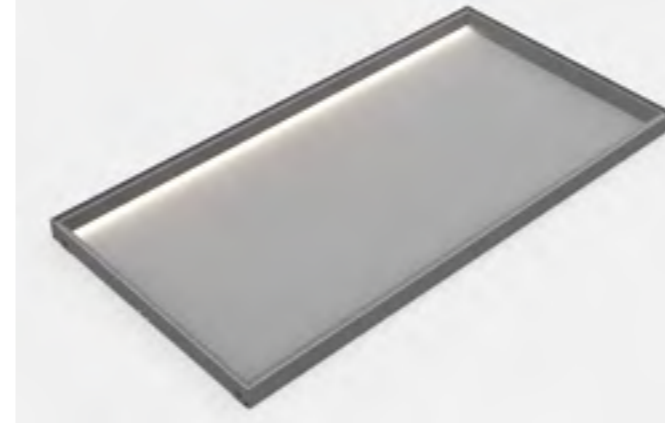

K3273

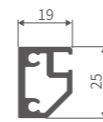

K3274

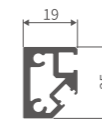

K3288

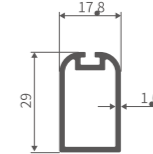

K1552

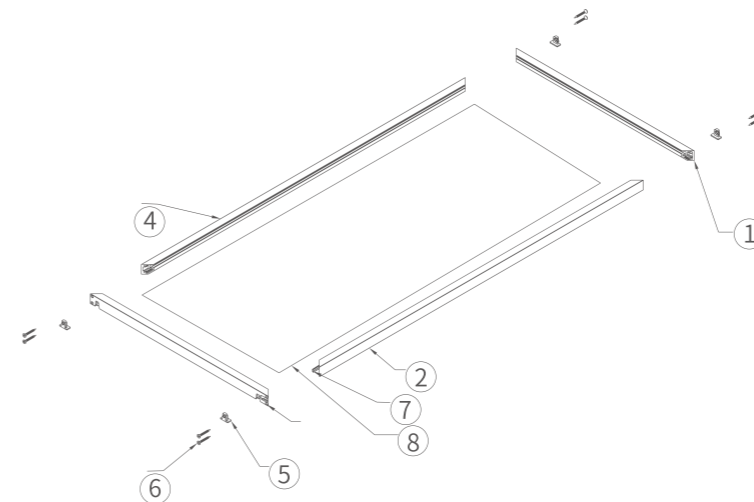
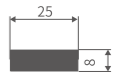

序号	名称	说明
1	斜层板右侧框	K3273
2	斜层板前框	K3274
3	斜层板左侧框	K3273
4	斜层板后框	K3273
5	层板托	
6	ST4*30自攻丝	
7	灯盖	
8	5mm玻璃	

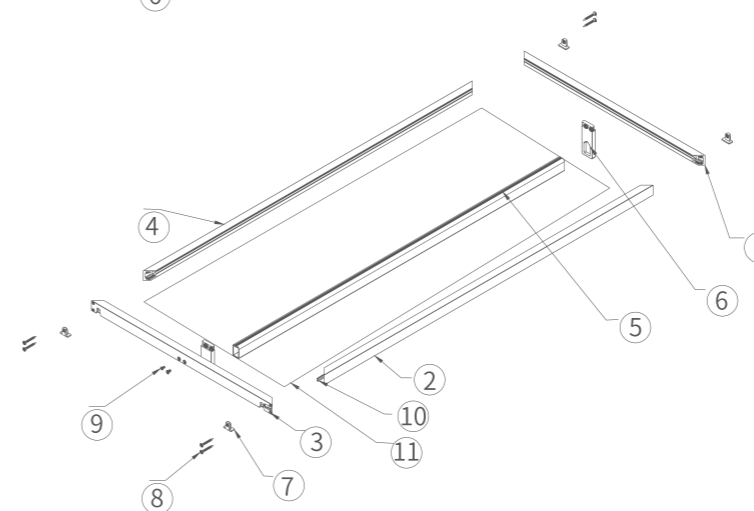

序号	名称	说明
1	斜层板右侧框	K3273
2	斜层板前框	K3274
3	斜层板左侧框	K3273
4	斜层板后框	K3273
5	衣通杆	
6	衣通座	
7	层板托	K3288
8	ST4*30自攻丝	K1199
9	M5*8机丝	
10	灯盖	
11	5mm玻璃	

铝框玻璃层板 CB-B004



K3263 玻璃层板侧框

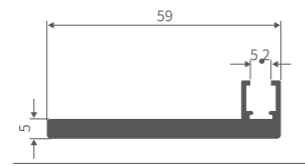

K3264 玻璃层板前框

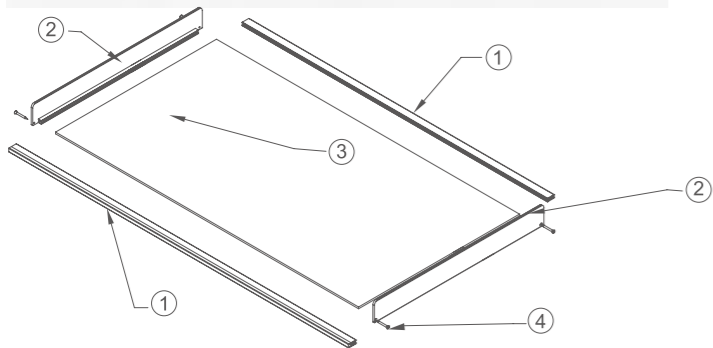
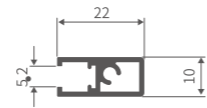

序号	名称	说明
1	前后框	K3264
2	左右侧框	K3263
3	玻璃	
4	ST4.2*25组装层板用自攻丝	

铝框玻璃层板 CB-B007



K2066 框料

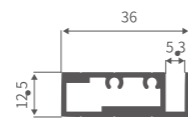

K2065 带灯槽框料

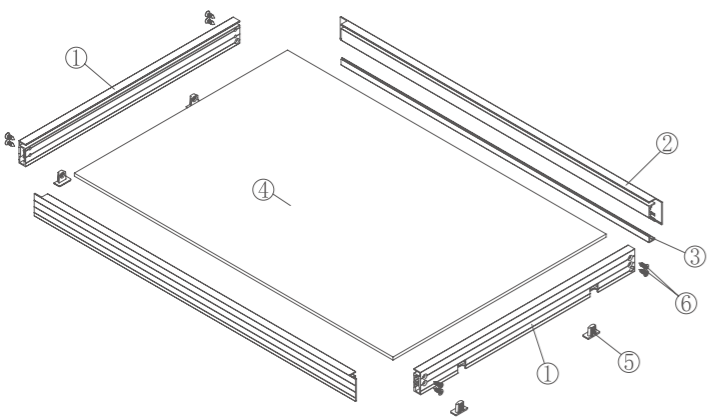
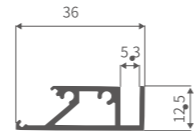

序号	名称	说明
1	框料	K2066
2	带灯槽框料	K2065
3	灯盖	
4	5mm玻璃	
5	层板扣	
6	M3.5x25沉头自攻螺丝	

铝框玻璃层板 CB-B006



铝框木层板 CB-L001

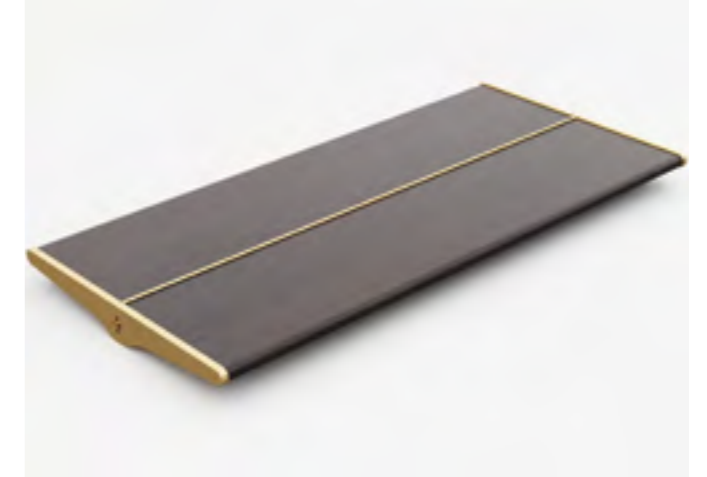

铝框玻璃层板 CB-B005

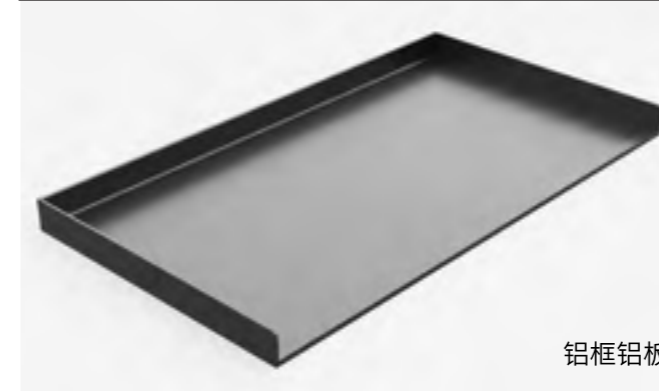

K3262 玻璃层板后框

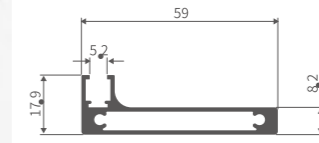

K3263 玻璃层板侧框

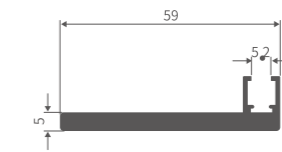

K3264 玻璃层板前框

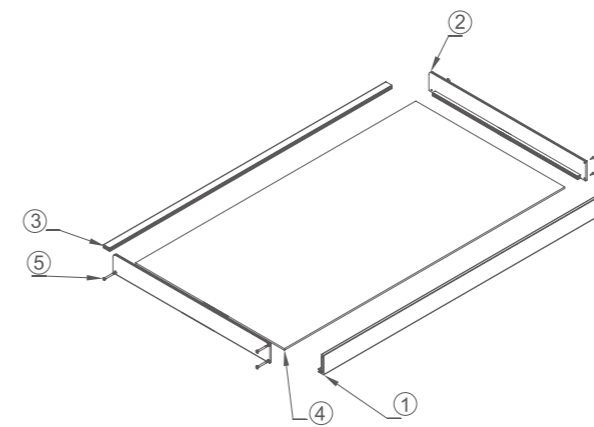
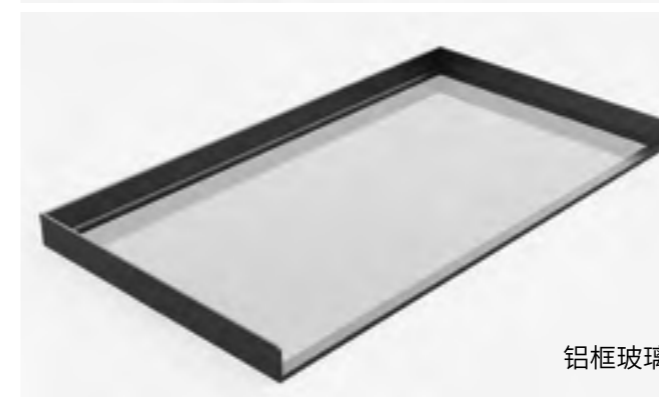
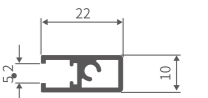

序号	名称	说明
1	前后框	K3262
2	左右侧框	K3263
3	前框	K3264
4	玻璃	
5	ST4.2*25组装层板用自攻丝	
6	斜层板胶条	

铝框玻璃层板 CB-B008

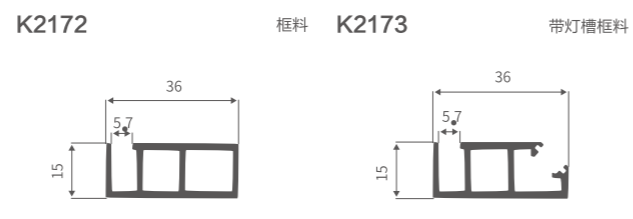
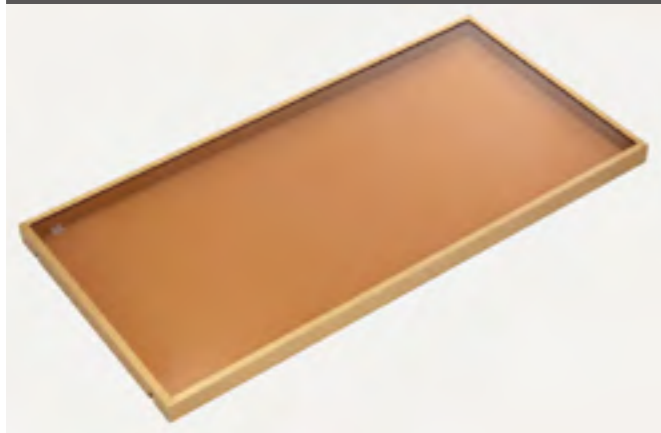

序号	名称	说明
1	框料	K2172
2	带灯槽框料	K2173
3	灯盖	
4	5mm玻璃	
5	层板扣	
6	M4x10内六角沉头机丝	
7	角码	

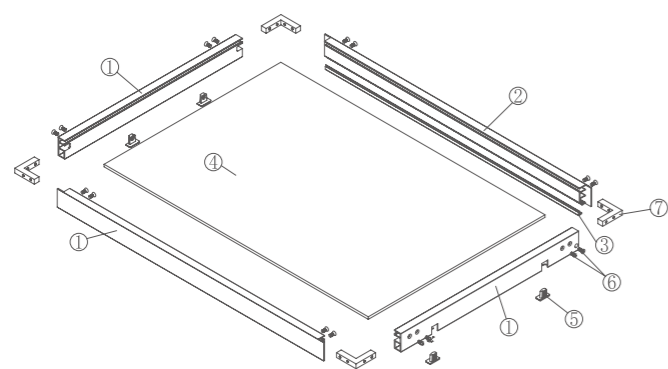

铝框玻璃层板 CB-B010

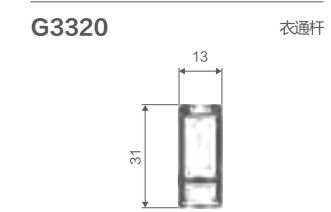
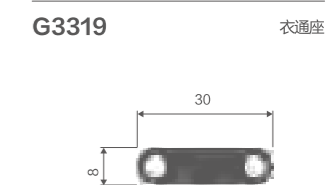
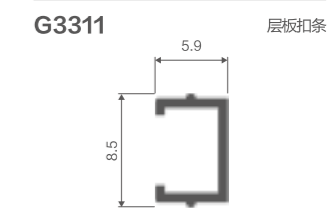
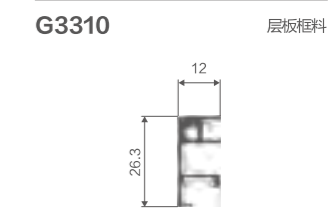
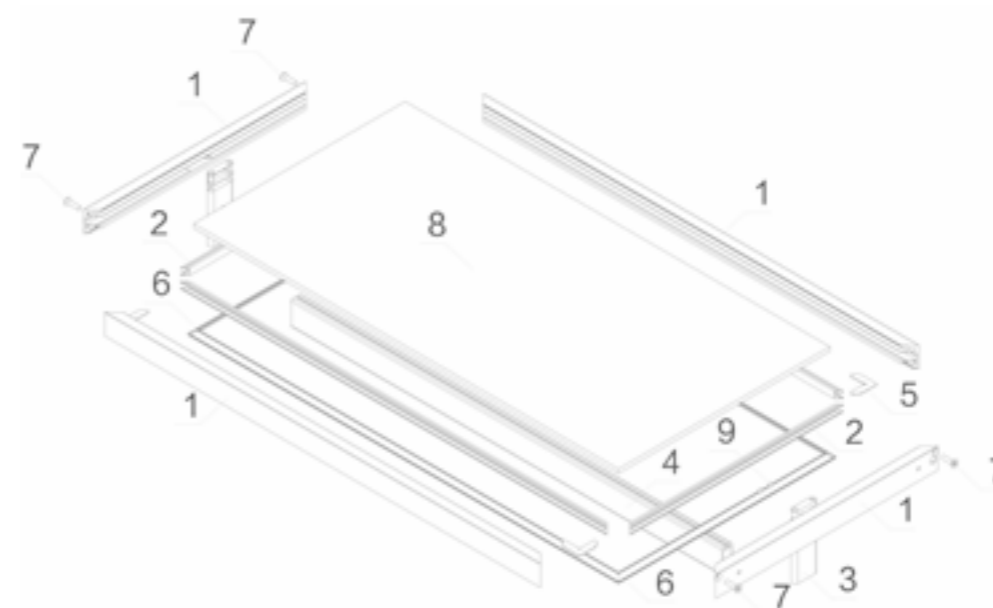
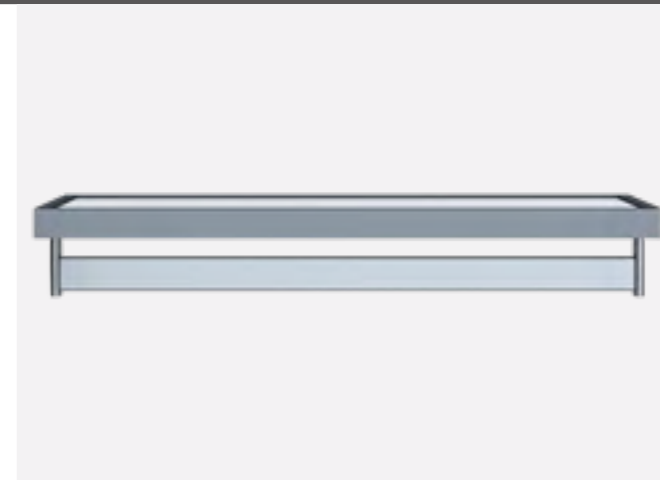
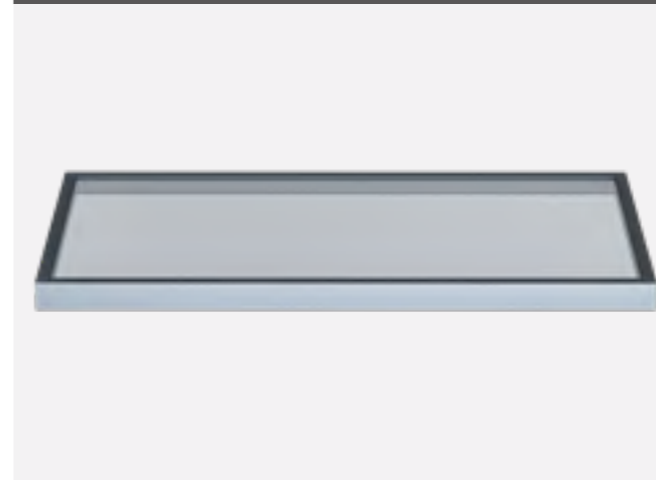

项目号	零件号	说明
1	层板框料	G3310
2	层板扣条	G3311
3	衣通座	G3319
4	衣通杆	G3320
5	层板角码	
6	灯盖	
7	自攻螺丝ST3.8*20	
8	玻璃	
9	紧定螺丝内六角凹端M4*4	

铝框玻璃层板 CB-B009

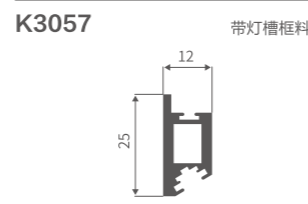
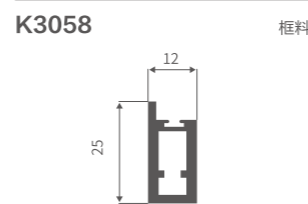

序号	名称	说明
1	框料	
2	带灯槽框料	K3516
3	灯盖	K3517
4	6mm玻璃	
5	层板扣	
6	M4x10内六角沉头机丝	
7	角码	
8	玻璃胶条	

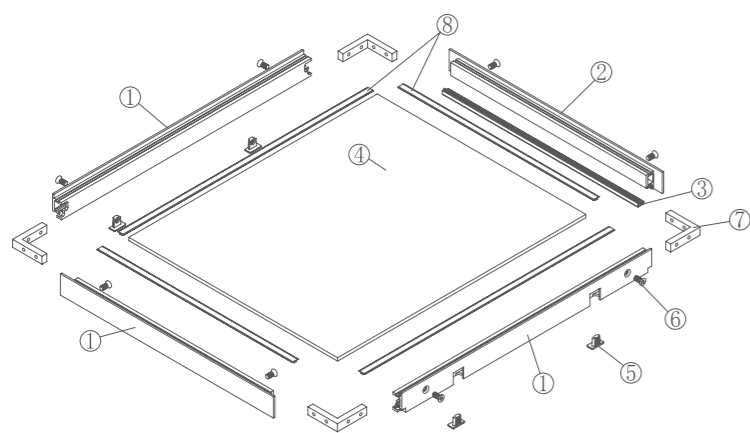

铝框玻璃鞋层板 CB-X001

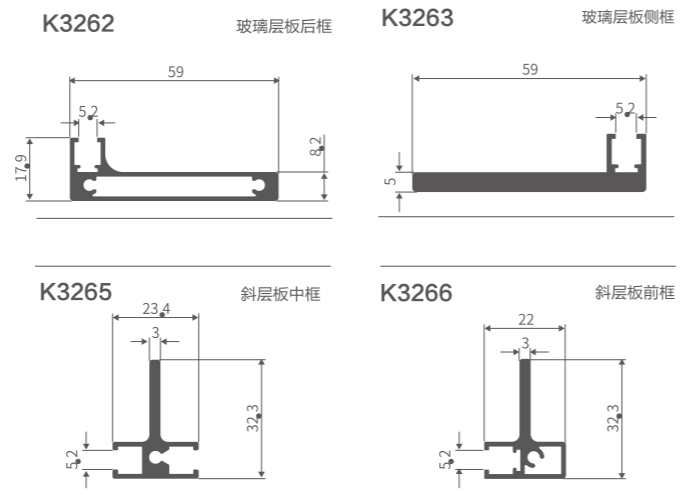

序号	名称	说明
1	斜层板后框	K3262
2	斜层板左右侧框	K3263
3	斜层板胶条	
4	斜层板玻璃	
5	斜层板前框	K3266
6	斜层板中框	K3265
7	ST4.2X35十字自攻丝 (组装层板用)	

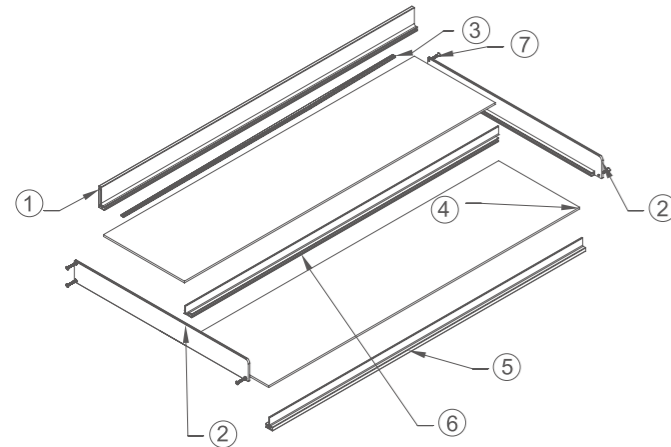

鞋木层板 CB-X002

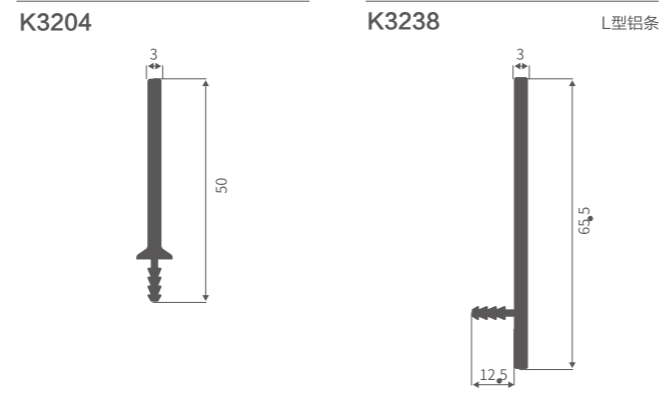

序号	名称	说明
1	斜层板前档	K3204
2	斜层板中档	K3238
3	木层板托A	
4	木层板托B	
7	木板	

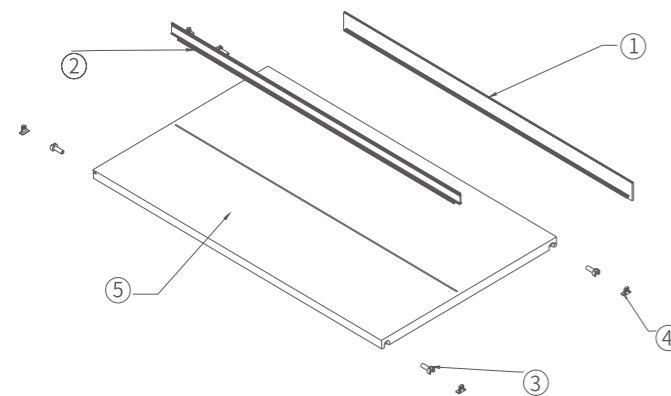

酒架层板 CB-J001

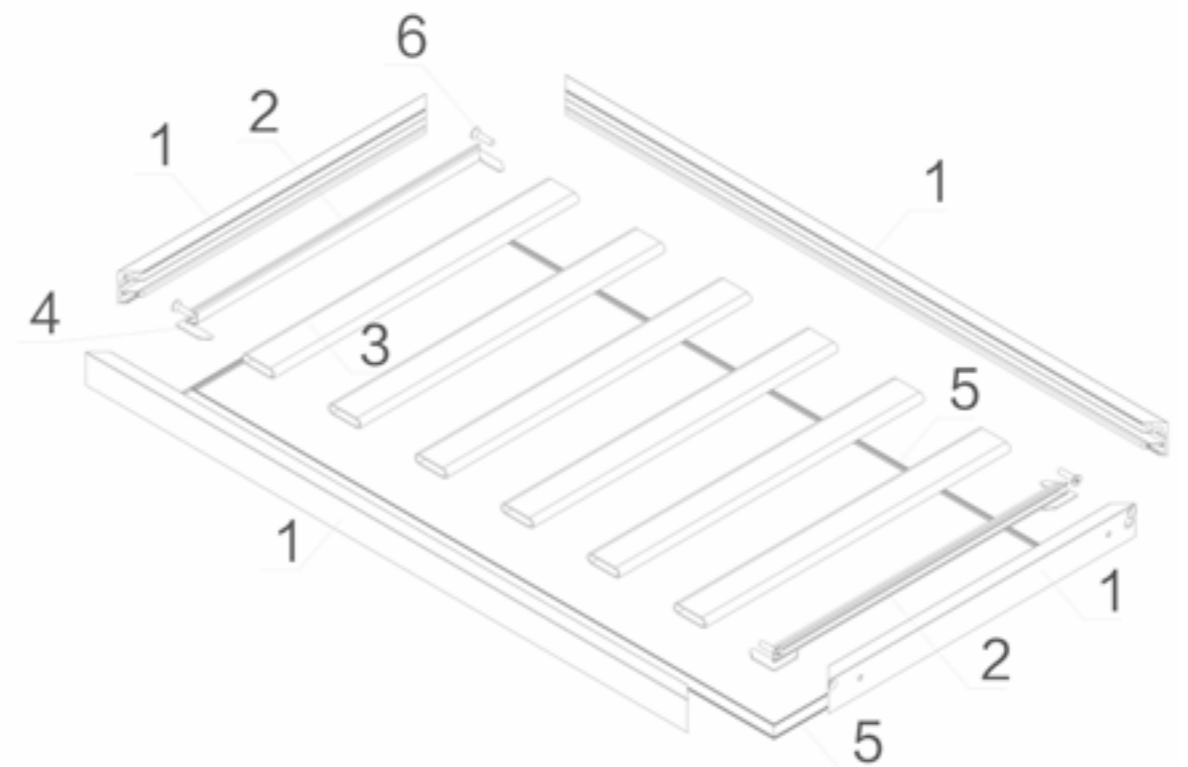
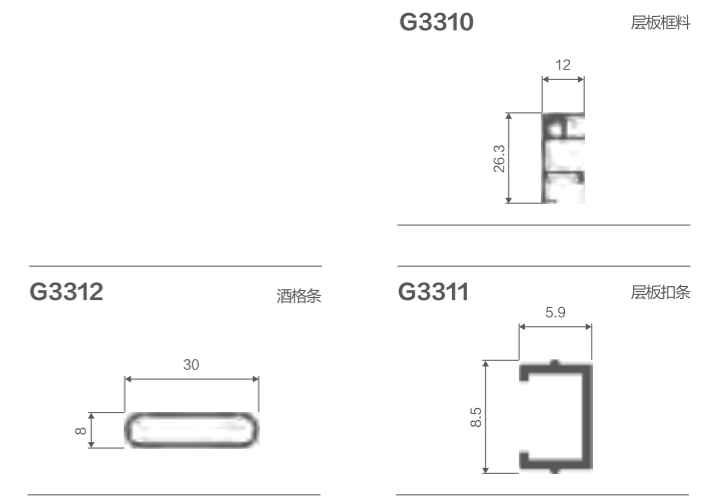

项目号	零件号	说明
1	层板框料	G3310
2	层板扣条	G3311
3	酒格条	G3312
4	层板角码	
5	灯盖	
6	自攻螺丝ST3.8*20	



K3257

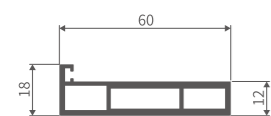

K3258

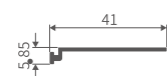

K3261

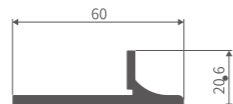

K3260

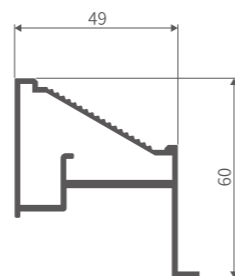

K3259

收纳导轨 (选配)

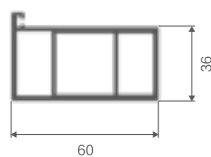

K3231

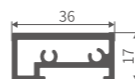

K3233

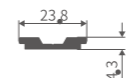

K3234



K3260

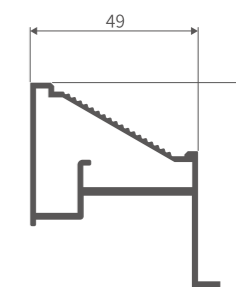

K3258

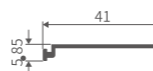

K3261



K3257



序号	名称	说明
1	收纳框=拉手	K3261
2	收纳框=前框	K3260
3	收纳框=后框	K3260
4	收纳框=左侧框	K3260
5	收纳框=右侧框	K3260
6	3节轨=500右	
7	3节轨=500左	
8	皮装饰盒	
9	收纳导轨	K3257
10	BS24=18板导轨堵头	
11	抽屉=导轨盖板	K3258
12	收纳框角码	
13	M4*25机丝	
14	M5*25机丝	
15	M5*8机丝	
16	M5*12机丝	

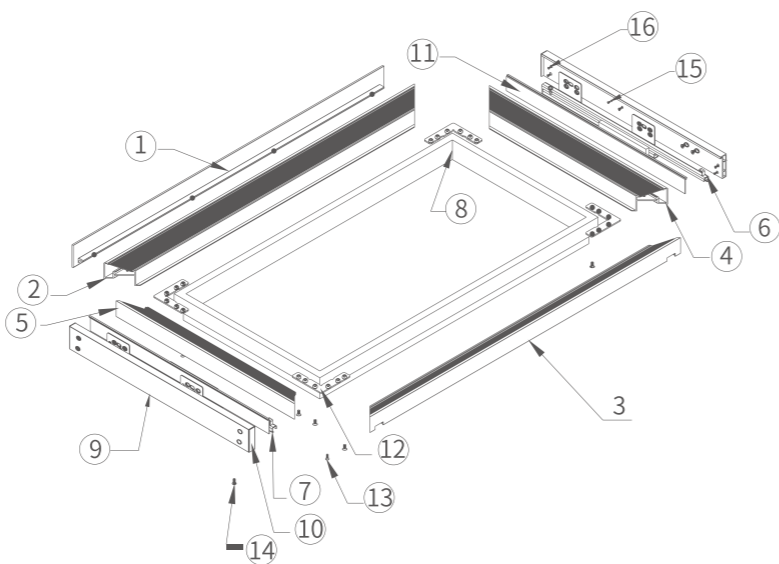

序号	名称	说明
1	收纳框=拉手	K3261
2	收纳框=前框	K3260
3	收纳框=后框	K3260
4	收纳框=左侧框	K3260
5	收纳框=右侧框	K3260
6	3节轨=500右	
7	3节轨=500左	
8	裤架轨道	K3231
9	收纳导轨	K3257
10	BS24=18板导轨堵头	
11	抽屉=导轨盖板	K3258
12	收纳框角码	
13	挂裤杆	K3234
14	滑块	K3233
15	ST4=30自攻丝	
16	M4*25机丝	
17	M5*25机丝	
18	M5*8机丝	
19	M5*12机丝	

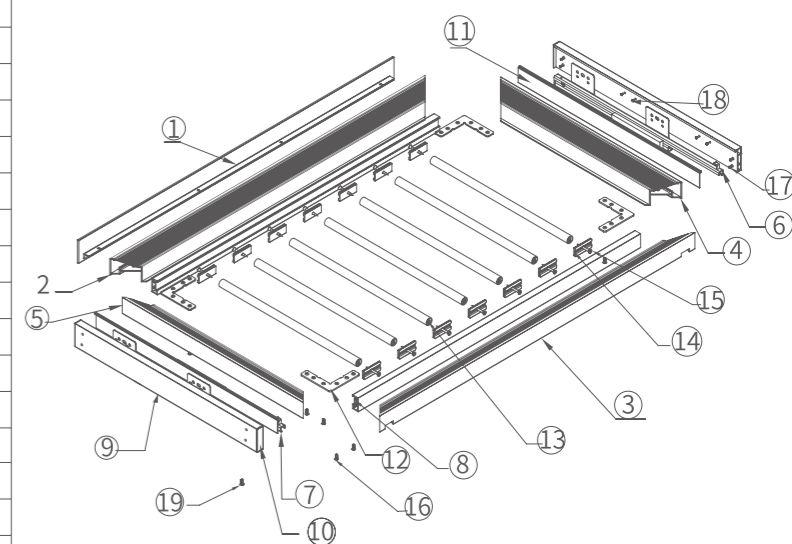

L 型发光置物架 ZWJ001



产品特点 —

极简现代轻奢搭配，时尚美观实用灯条隐藏在铝合金背面，无光点双面照射，上下发光，营造极佳灯光氛围的同时，解决了墙面的多层收纳，既是收纳也是家居艺术的展现应用于墙面层板架



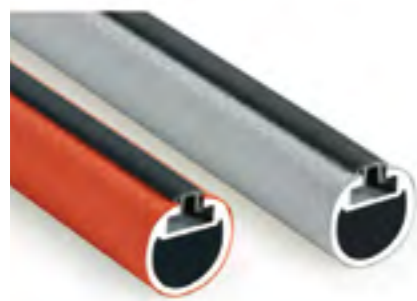

意式衣杆 YT001
颜色: 古铜金 + 橙色皮
灰色 + 灰皮
尺寸: 定制

K3524 圆管

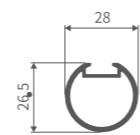

意式衣杆 YT002
颜色: 拉丝金
尺寸: 定制

K3525

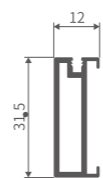

K1117

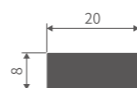

意式衣杆 YT003
颜色: 香槟金、绅士灰、摩卡棕、
哑黑 (烤漆色可选)
尺寸: 定制

K3526 圆管

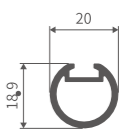

意式衣杆 YT004
颜色: 香槟金、绅士灰、摩卡棕、
哑黑 (烤漆色可选)
尺寸: 定制

K3527 圆管

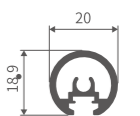

酒杯 / 酒瓶架系统 Wine glass/bottle rack system

Wine Glass/Bottle Rack Series

酒杯 / 酒瓶架系列

【意式极简】

设计理念：

设计遵循“少即是多”设计原则，崇尚合理的工艺，
重视材料的质感，优雅香槟黑金配色，
冷冽而华贵，上演纸醉金迷的极致氛围





红酒架

组合安装方法

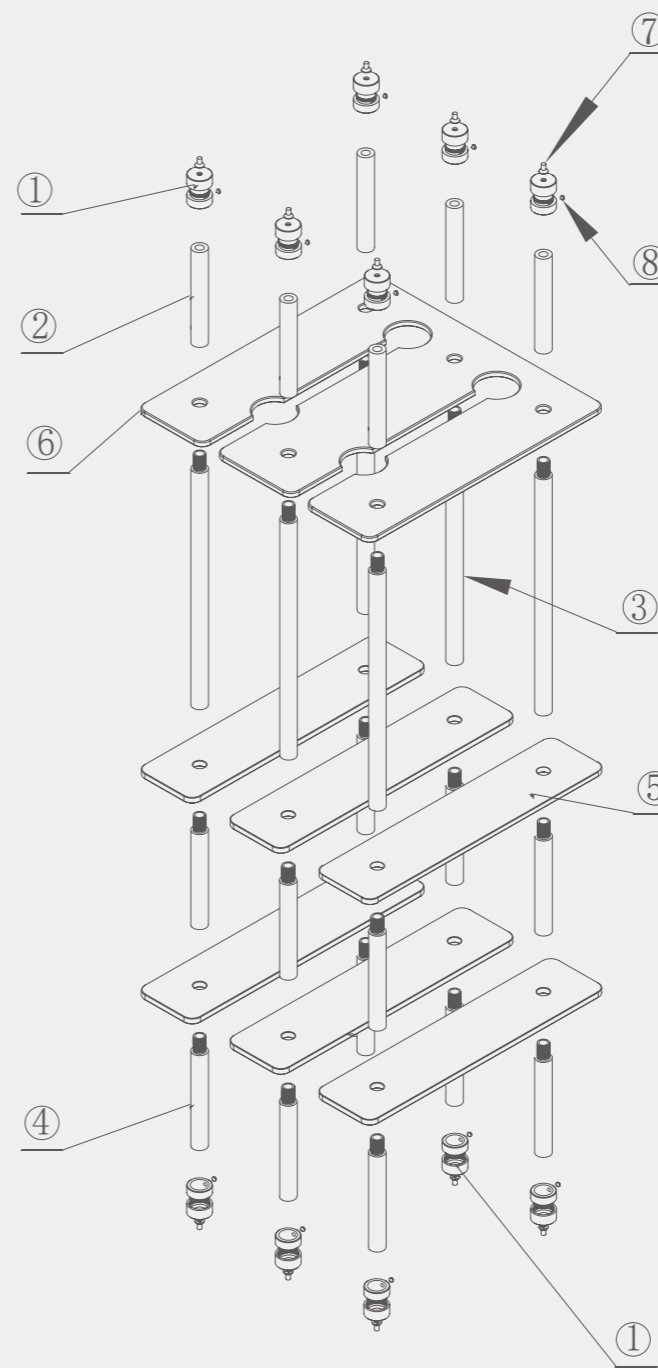

序号	名称	说明
1	顶底套脚	
2	顶部圆管	
3	酒杯挂圆管	
4	底部圆管	
5	铝层板	
6	酒杯挂	
7	平头内六角M4*8	
8	紧钉螺丝M3*4	

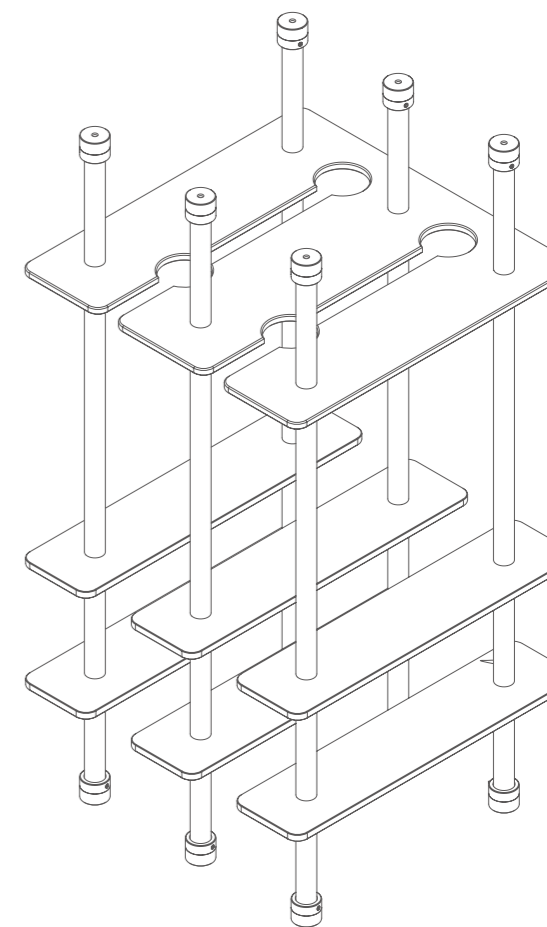

铝框酒架层板 CB-J001



铝框酒架层板 CB-J002(皮革表面)



皮革颜色: 米杏白 意式灰 摩卡棕

K3230 酒格层板前灯

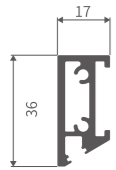

K3231 酒格层板侧框

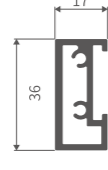

K3233 酒格层板滑块

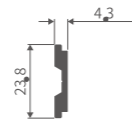

K3234 酒格层板圆管

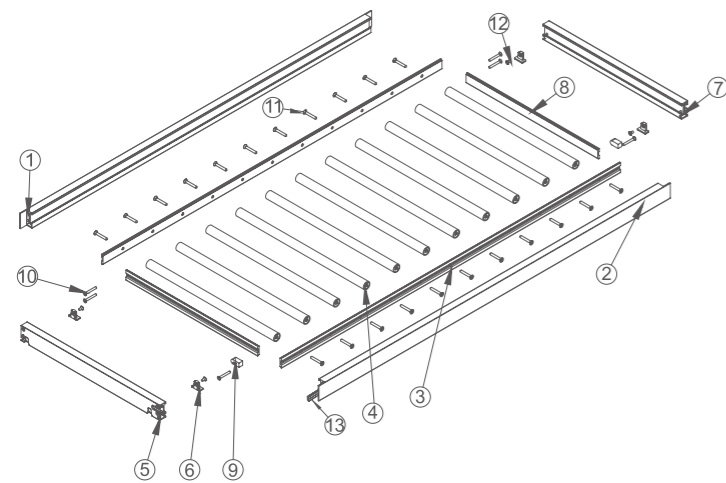

序号	名称	说明
1	酒后料	K3231
2	酒前灯	K3230
3	酒滑块	K3233
4	酒圆管	K3234
5	酒架左框	K3231
6	木层板托-锌合金	
7	酒架右框	K3231
8	左右酒架滑块	K3233
9	层板触点	导电连接头
10	平头十字自攻螺丝ST4.2X32	
11	平头十字自攻螺丝ST 2X32	
12	平头内六角M4X8	
13	灯盖	

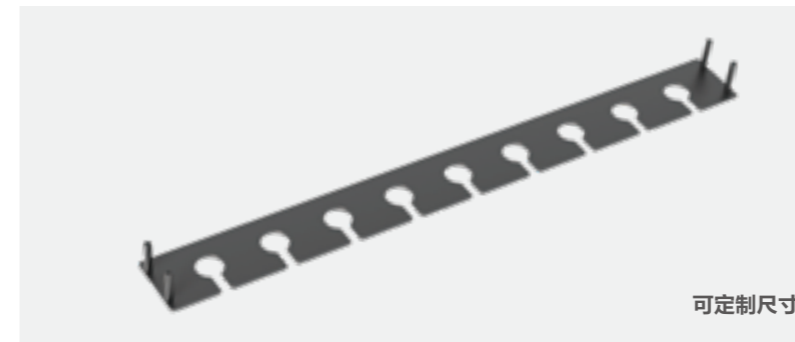

可定制尺寸



KA04



可定制尺寸



KA06

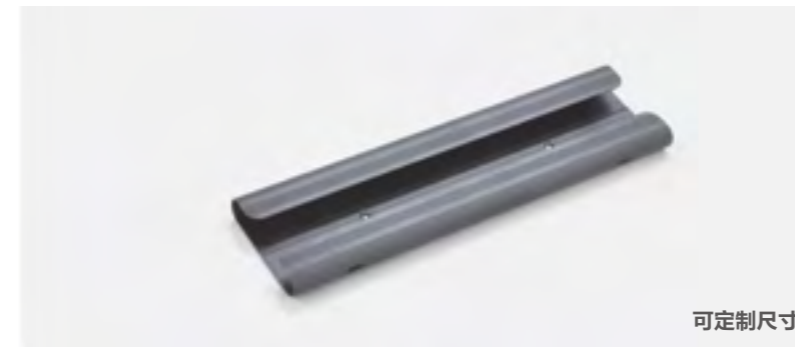

可定制尺寸

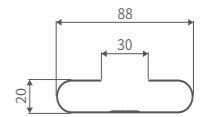

KA03



可定制尺寸



KA05



可定制尺寸



KA07



100 挂墙式红酒架

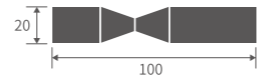

KA01



木层板酒托

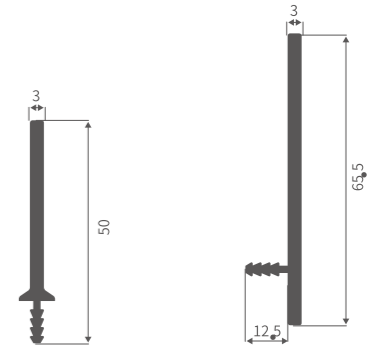

K3204

K3238



200 挂墙式红酒架

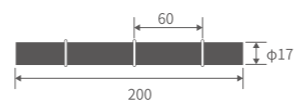

KA02



挂墙式创意酒架

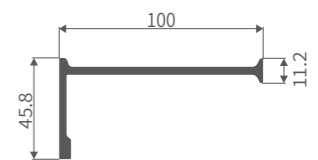

KA04

【极简 - 移门 / 生态门】

玻璃与金属的触感与质感共同呈现出静谧的空间格调
简约明亮而大方不仅可以为家居增添高品质感还带来意想不到的优雅。

Minimalist Sliding Door

极简吊门 - DM001

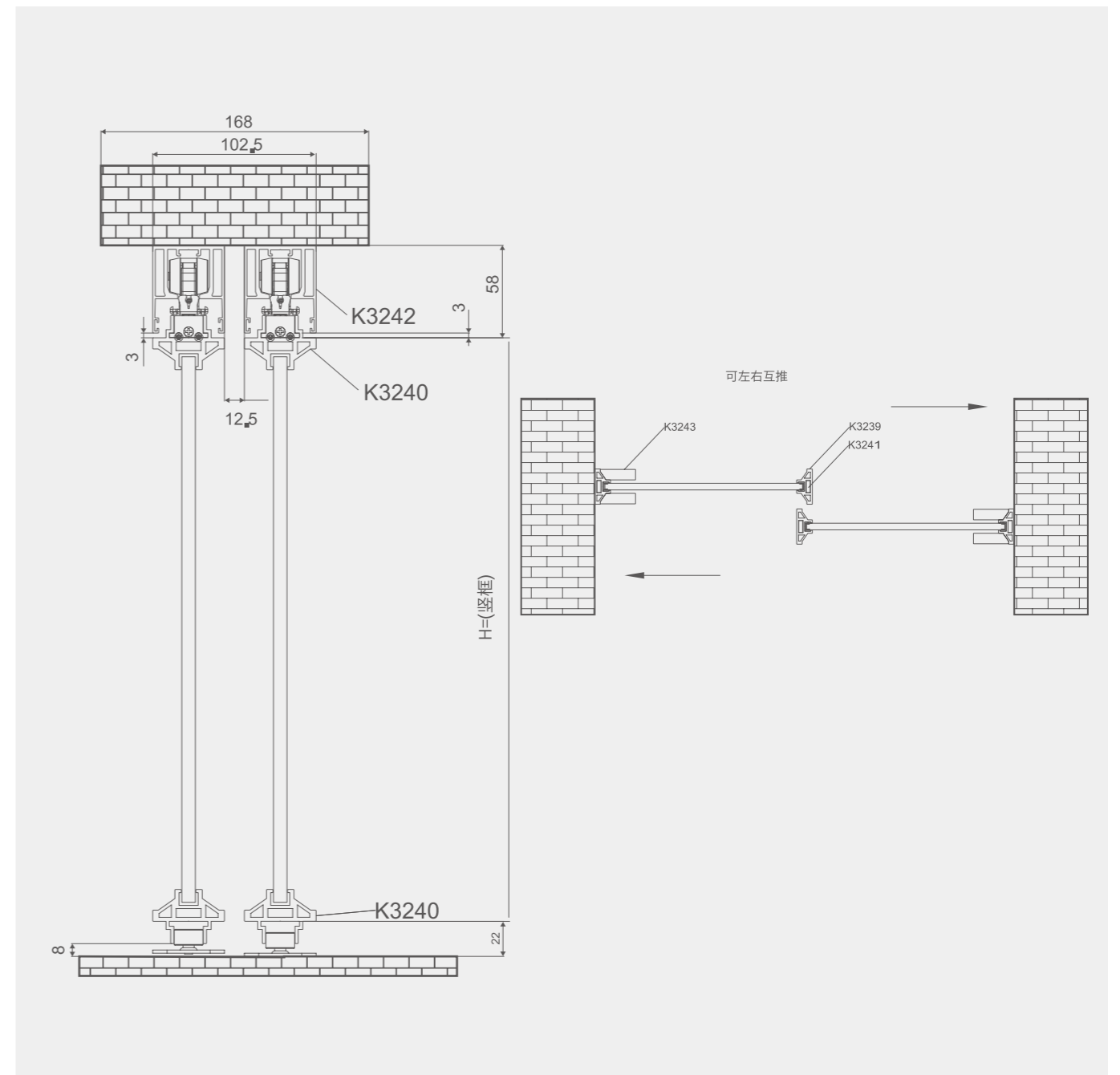

神舟 11 号 - 双阻尼

吊门定制款拉手

斜边吊门角码

8mm/8.5mm 玻璃胶条

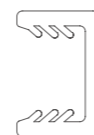
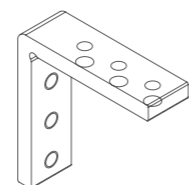
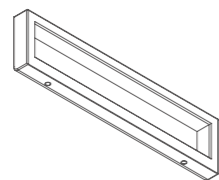
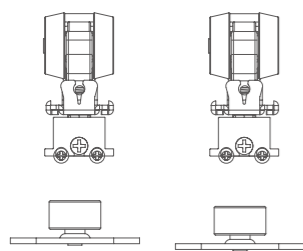

K3239

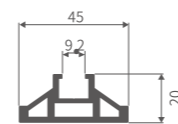

K3240

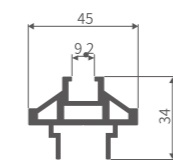

K3241

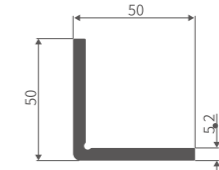

K3242

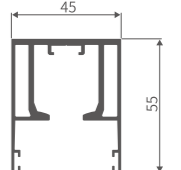

K3243



极简吊门 - DM002

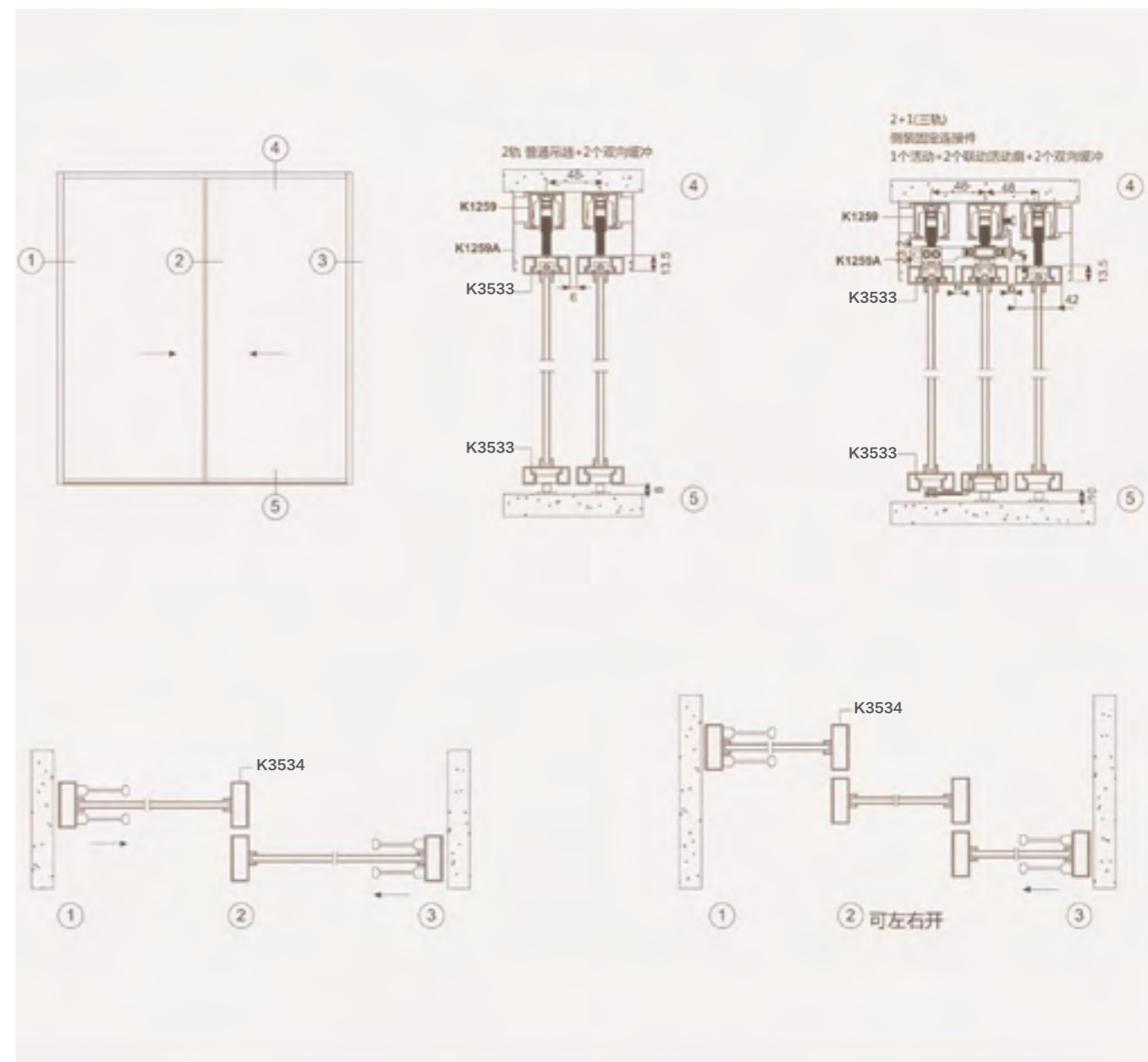

角码



BNS-01

二头带缓冲单轨吊轮(选配)



拉手(选配)



BNS-02

不带缓冲单轨吊轮(选配)



拉手(选配)

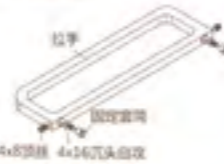

BNS-03

吊趟联动2+1(固定款)



BNS-04

吊趟联动2+1(活动款)



K1259

多用吊轨



重量: 0.82kg/m

K1259A

吊轨吊道



重量: 0.33kg/m

K3588

6mm单玻上下轨

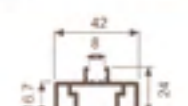

重量: 0.78kg/m

K3534

6mm单玻固定光企

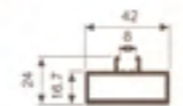

重量: 0.75kg/m

MA10404(选配)

8mm单玻上下轨

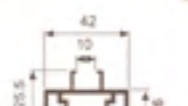

重量: 0.71kg/m

MA10405(选配)

8mm单玻固定光企

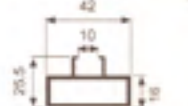

重量: 0.67kg/m

极简吊门 - DM003

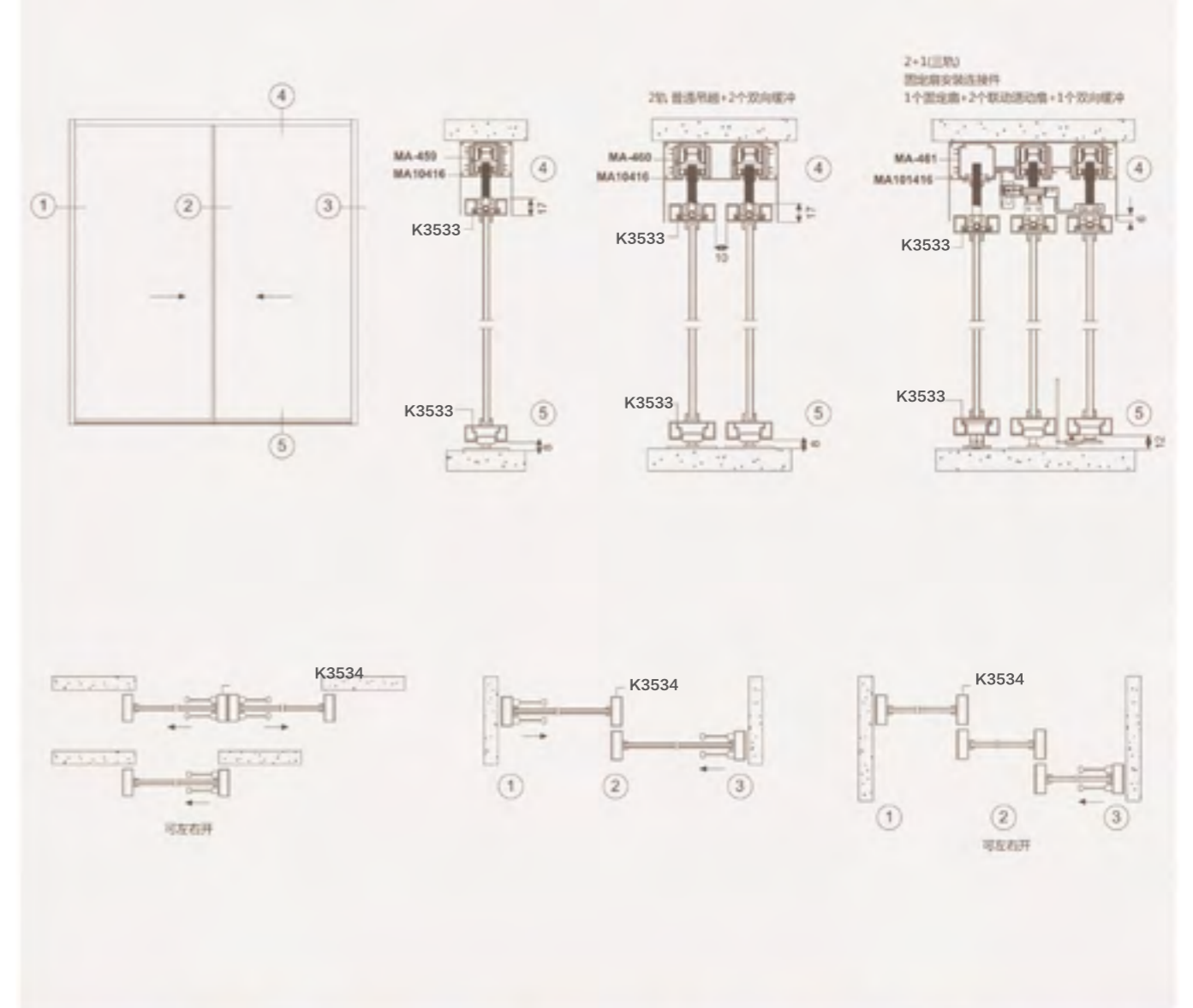

角码



TN758B 单阻尼吊轮(选配)



拉手(选配)



CN212261A 吊趟联动2+1

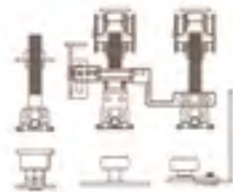

拉手(选配)

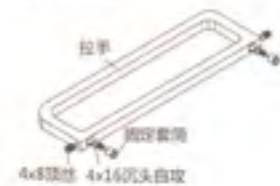

MA-459

多用滑轮



MA10416

重量: 1.20kg/m

MA-460

两用滑轮



MA10416

重量: 2.20kg/m

MA-461

三轨滑轮



MA10416

重量: 3.37kg/m

MA10416

滑轮衬套

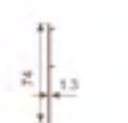

重量: 0.28kg/m

K3533

6mm单玻璃上下滑

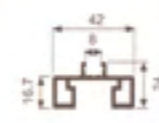

重量: 0.79kg/m

K3534

6mm单玻璃光企

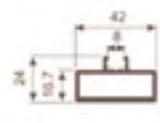

重量: 0.79kg/m

MA10404(选配)

8mm单玻璃上下滑

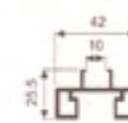

重量: 0.71kg/m

MA10405(选配)



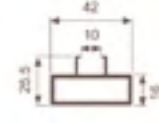

8mm单玻璃光企

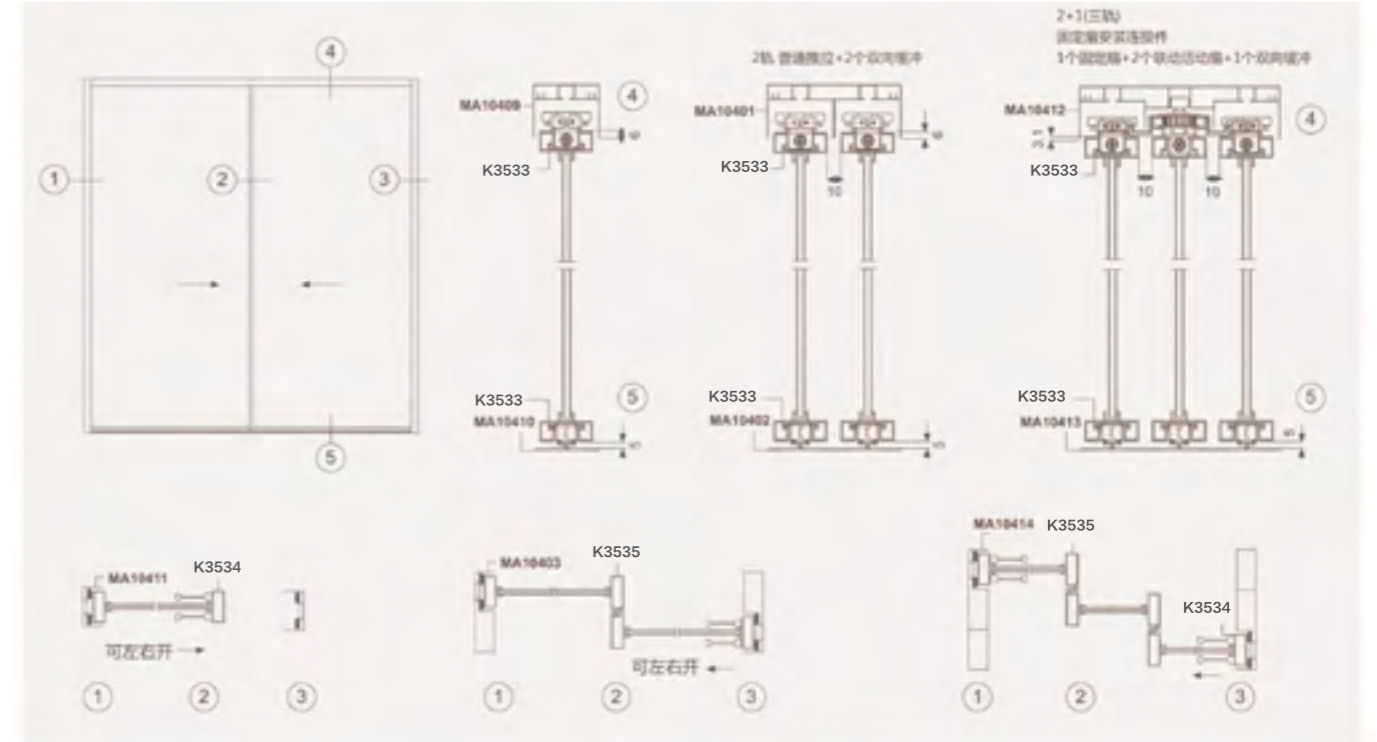

重量: 0.67kg/m

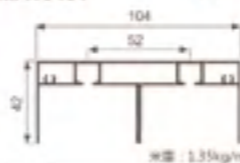
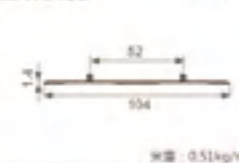
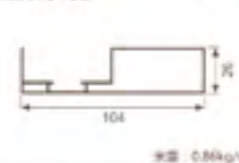
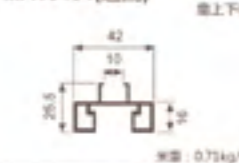
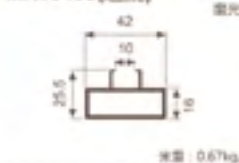
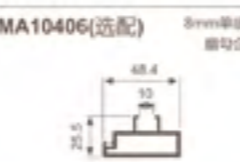
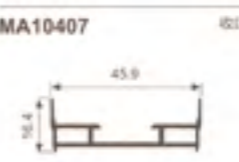
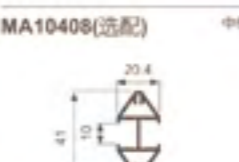
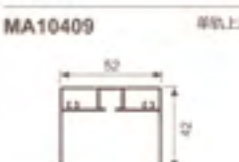
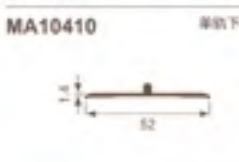
极简推拉门 - DM004

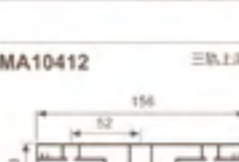
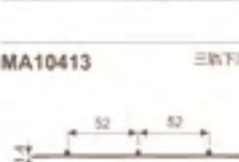
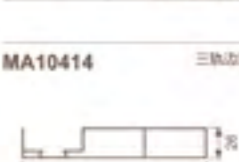

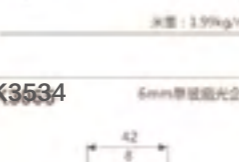
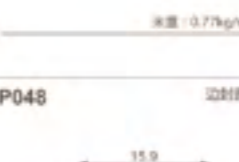
MA10401 两轨上滑  重量: 1.35kg/m	MA10402 两轨下滑  重量: 0.51kg/m	MA10403 两轨边封  重量: 0.84kg/m	MA10404(选配) 8mm单轨 单上下轨  重量: 0.73kg/m	MA10405(选配) 8mm单轨 单光企  重量: 0.67kg/m
MA10406(选配) 8mm单轨 前勾企  重量: 0.75kg/m	MA10407 收口  重量: 0.37kg/m	MA10408(选配) 中锁  重量: 0.51kg/m	MA10409 单轨上滑  重量: 0.74kg/m	MA10410 单轨下滑  重量: 0.25kg/m
MA10411 单轨边封  重量: 0.49kg/m	MA10412 三轨上滑  重量: 1.99kg/m	MA10413 三轨下滑  重量: 0.77kg/m	MA10414 三轨边封  重量: 1.34kg/m	K3066 6mm单轨前勾企 K3535  重量: 0.80kg/m
K3533 6mm单轨上下轨  重量: 0.78kg/m	K3534 6mm单轨前光企  重量: 0.73kg/m	P048 边封条  重量: 0.15kg/m		

角码

拉手带锁(选配)

拉手带锁(选配)

勾企胶条

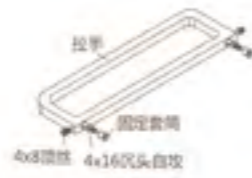

CN212259A三联动

14.8*815*14上轮

CJ212644下轮

P047边封胶条

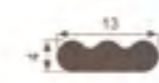

40 极简吊门 - DM005



TN1098A 三联动中门滑轮配件套装

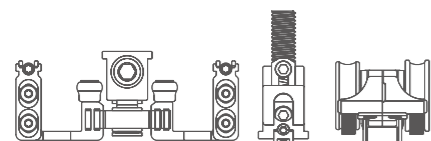

下定位

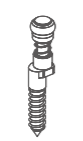

A411 收口 L 条

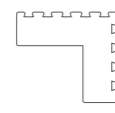

防摆轮

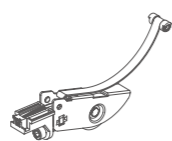

A504 包套扣板固定件

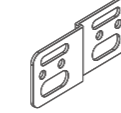

吊门定制款拉手



CA420001-0012 单门滑轮配件套装

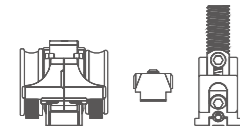

A506 角码片

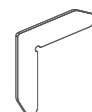

A507 角码

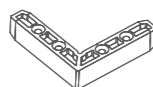

A502 塑料卡扣

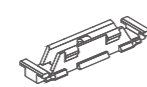

A501 轨道连接件

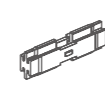

A408 8mm 玻璃胶条



A403 勾企密封胶条



A404 上轨减震胶条

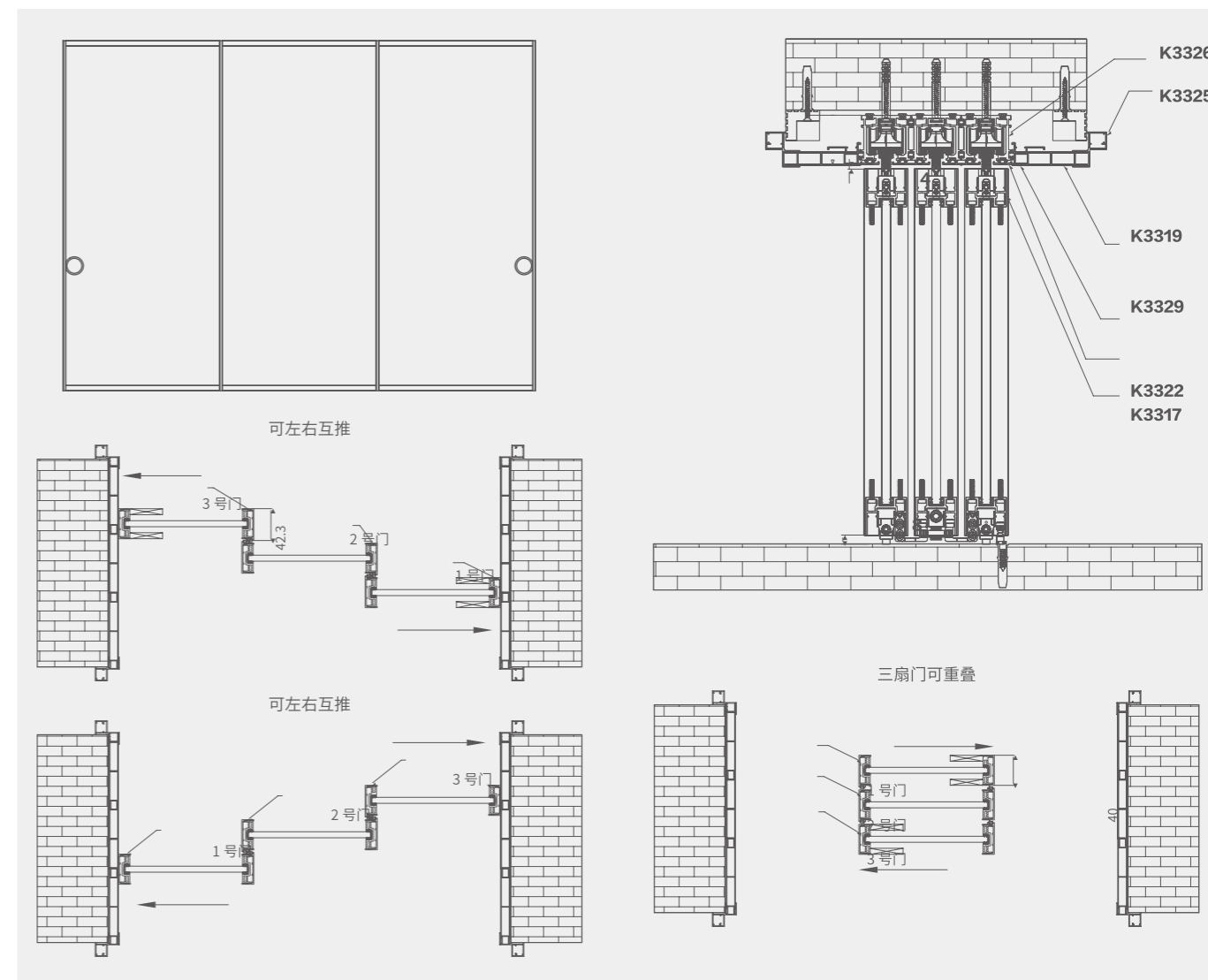

K3315

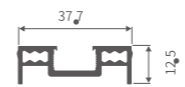

米重0.45kg/m

K3316

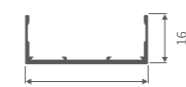

米重0.27kg/m

K3321



米重0.29kg/m

K3322

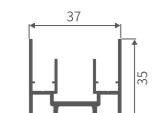

米重0.76kg/m

K3326

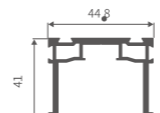

米重1.21kg/m

K3317

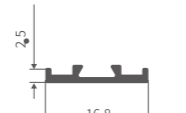

米重0.08kg/m

K3318

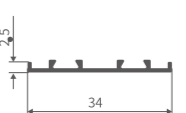

米重0.13kg/m

K3329

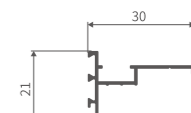

米重0.22kg/m

K3319

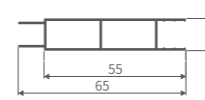

米重0.44kg/m

K3320

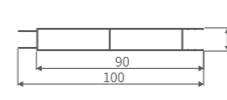

米重0.63kg/m

K3325

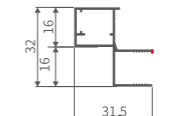

米重0.32kg/m

极简生态门 - STM001

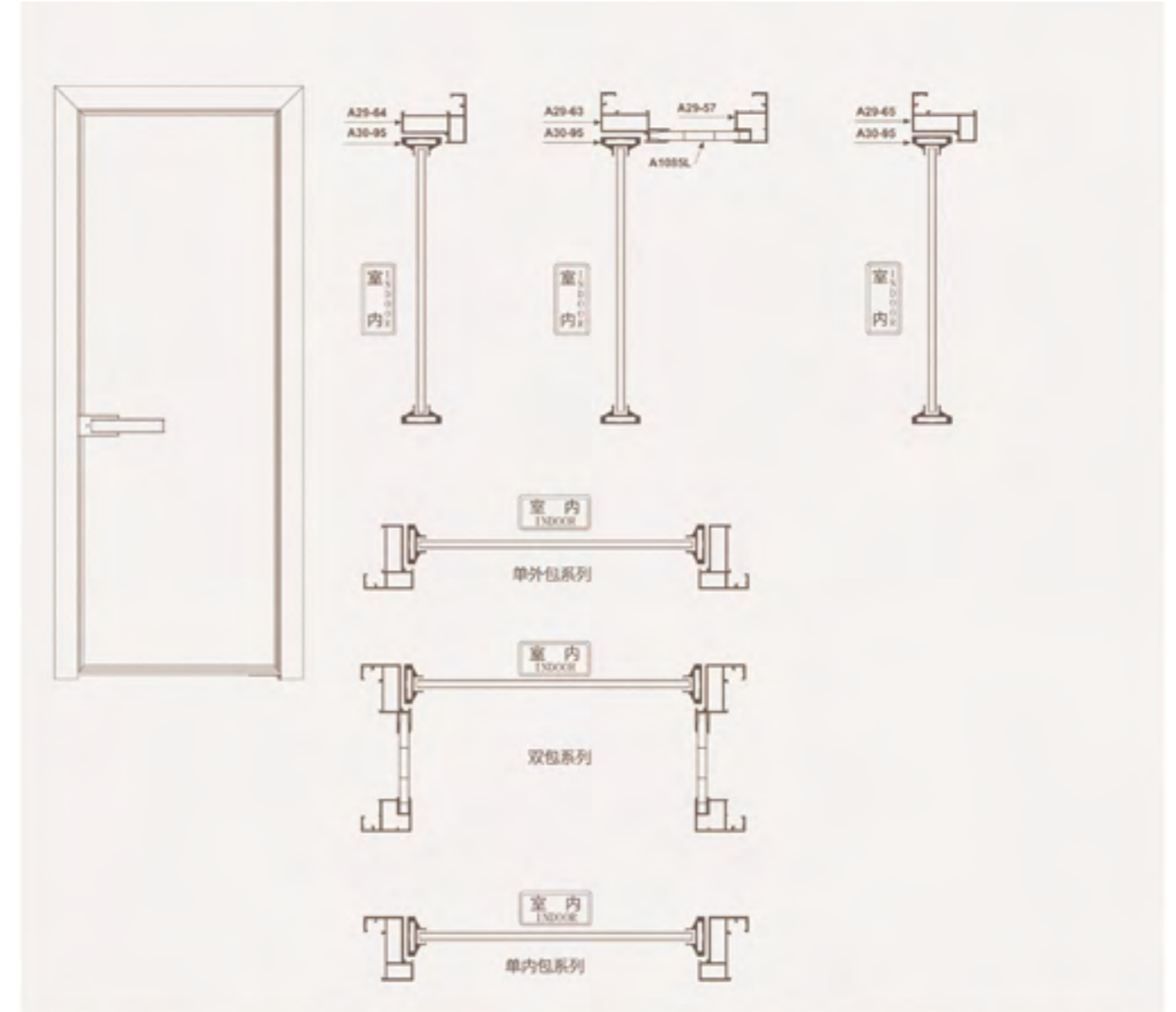

08极简天地合页



BL98E40 锁



14X28.5 铝角码



14X42.2 铝角码



4.2T铝角码



小铁角厚 2.588



七字铁角



XDH003B 胶条



A29-64 外包边框



壁厚: 2.0mm 米重: 1.30kg/m

A29-65 内包边框



壁厚: 2.0mm 米重: 1.34kg/m

A30-95 08玻璃夹

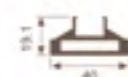

壁厚: 2.5mm 米重: 0.76kg/m

A29-57 双包外框



壁厚: 2.0mm 米重: 0.58kg/m

A29-63 双包内框



壁厚: 2.0mm 米重: 1.21kg/m

A1085L 10mm压板



壁厚: 0.8mm 米重: 0.506kg/m

极简生态门 - STM002



16天地合页 BL9840 锁 14X28.5 铝角码 14X42.2 铝角码



10.7铝角码上 10.7铝角码下 69-35.5 铝角码 小铁角厚 2.588 七字铁角 XDH003B 胶条

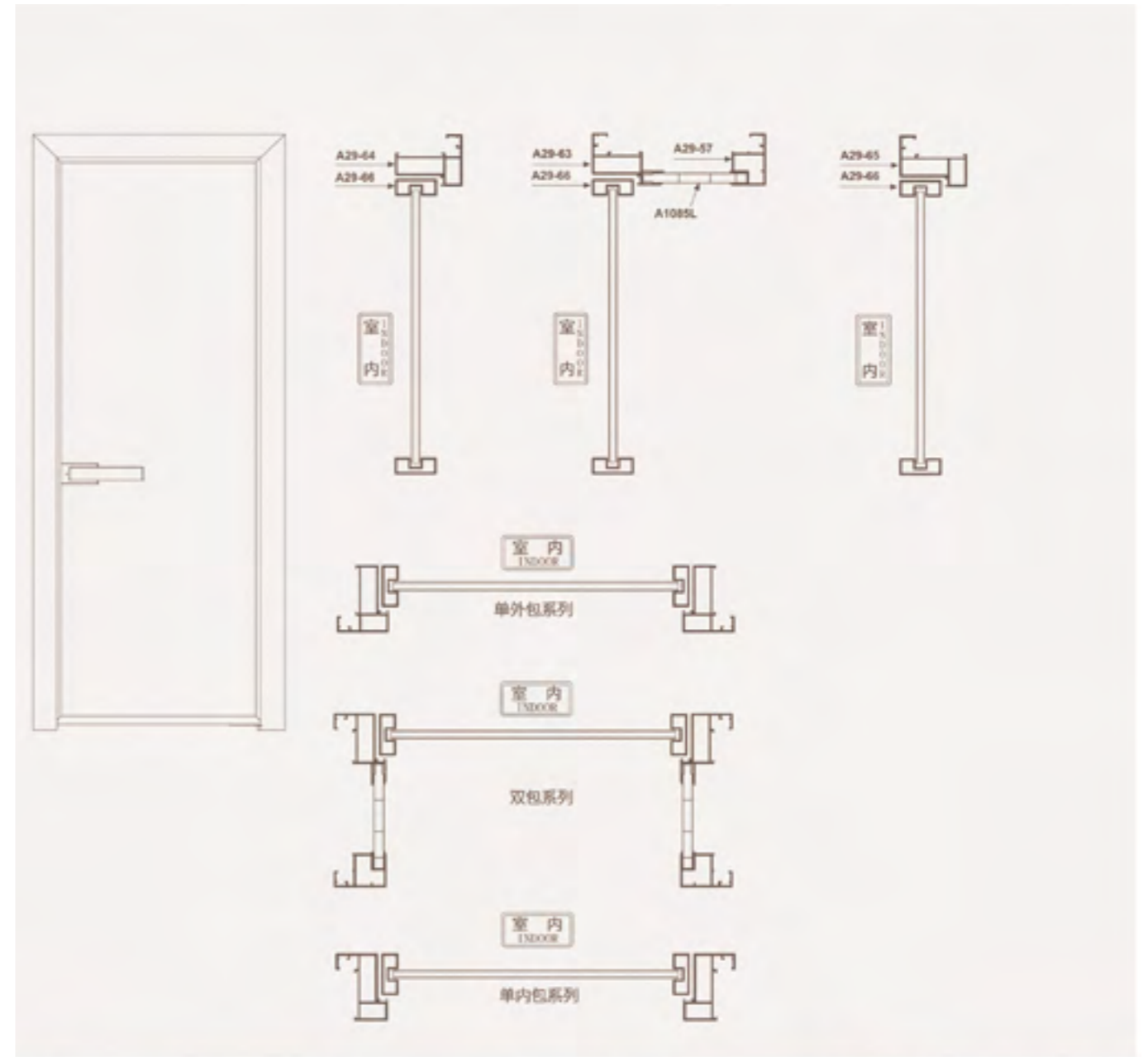
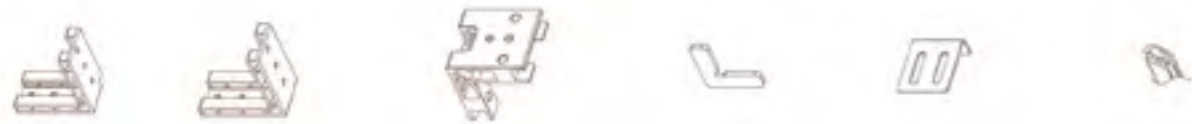

9-64 外包边框 A29-65 内包边框 A29-66 14天地 A29-57 双包外框



9-63 双包内框 A1085L 10mm胶条



极简生态门 - STM003

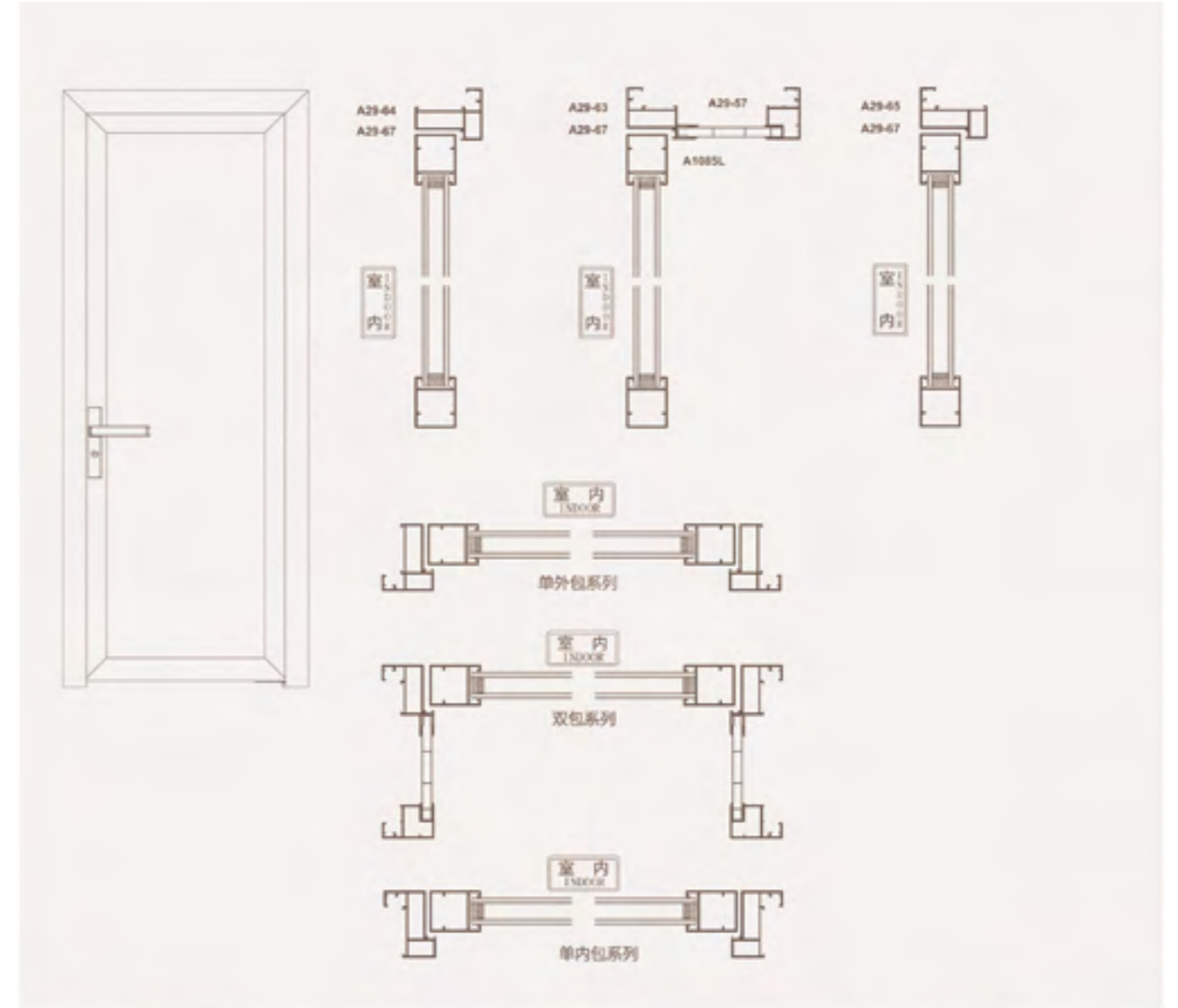

16天地合页

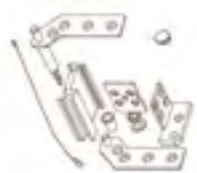

50锁



14X28.5 铝角码



14X42.2 铝角码



F21X35.5 铝角码



小铁角厚 2.588



七字铁角



XDH003B 胶条



A29-64

外包边框

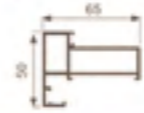

壁厚: 2.0mm 米重: 1.30kg/m

A29-65

内包边框



壁厚: 2.0mm 米重: 1.34kg/m

A29-67

50光企

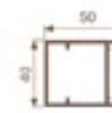

壁厚: 2.0mm 米重: 1.047kg/m

A29-57

双包外框



壁厚: 2.0mm 米重: 0.98kg/m

A29-63

窗包内框

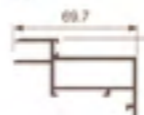

壁厚: 2.0mm 米重: 1.21kg/m

A1085L

10mm胶板



壁厚: 0.8mm 米重: 0.506kg/m

40 极致窄生态门 - STM004

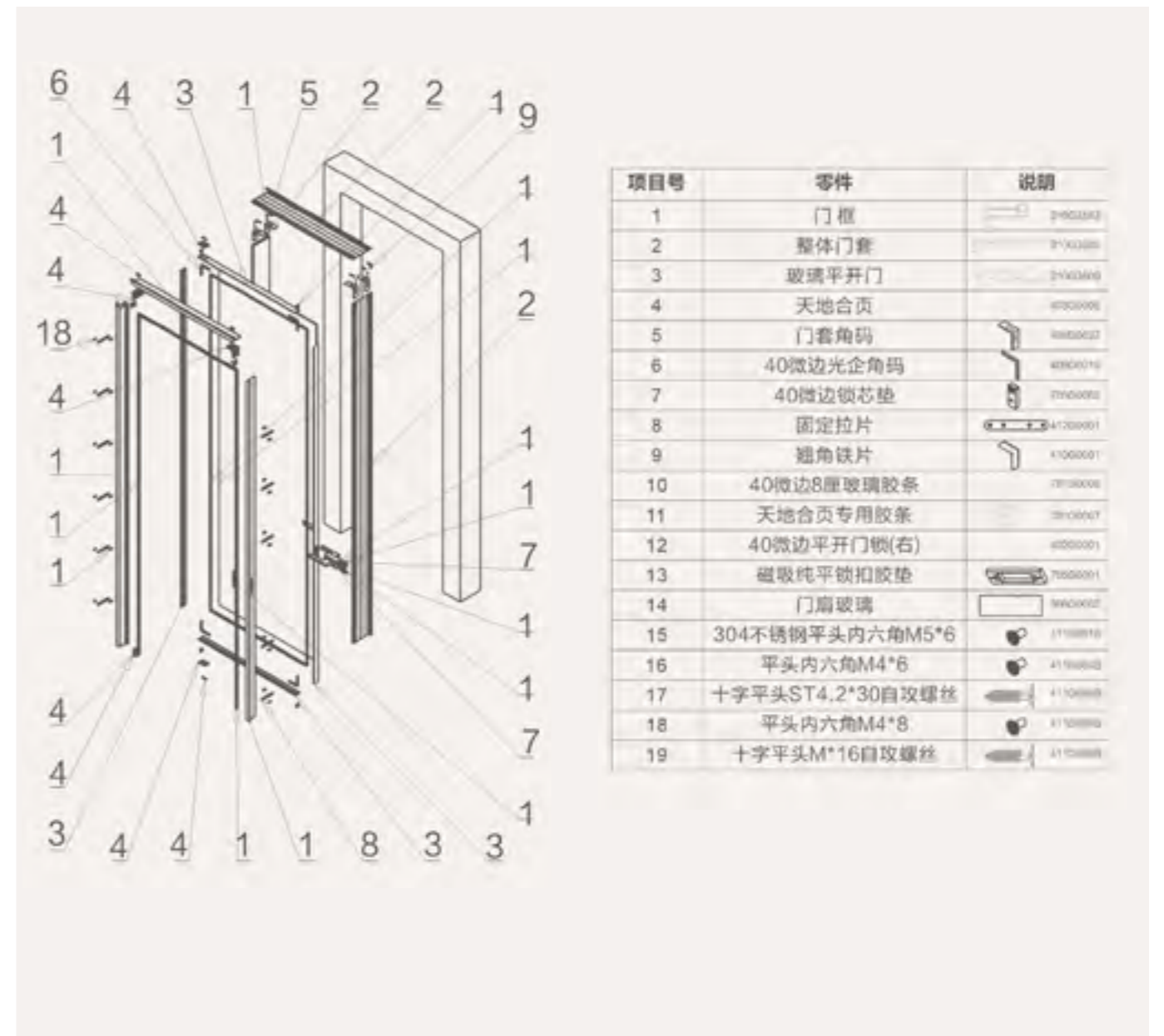

磁吸纯平锁扣胶垫



固定拉片



门套角码



翘角铁片



40 微边光企角码



40 微边锁芯垫



G3293 上框(下框)



G3293 竖框(铰链位)

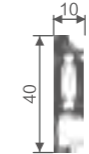

G3293 竖框(锁扣位)

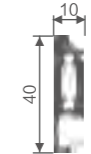

G3293 下框(上框)

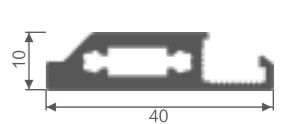

G3291 主框架(锁体位)

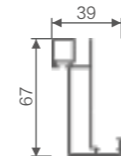

G3291 主框架(上横)

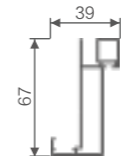

隐框铝木生态门 - STM005



合页垫片



极窄玻璃门 PU 发泡条



龙骨角码



门框角码



门套角码



翘角铁片

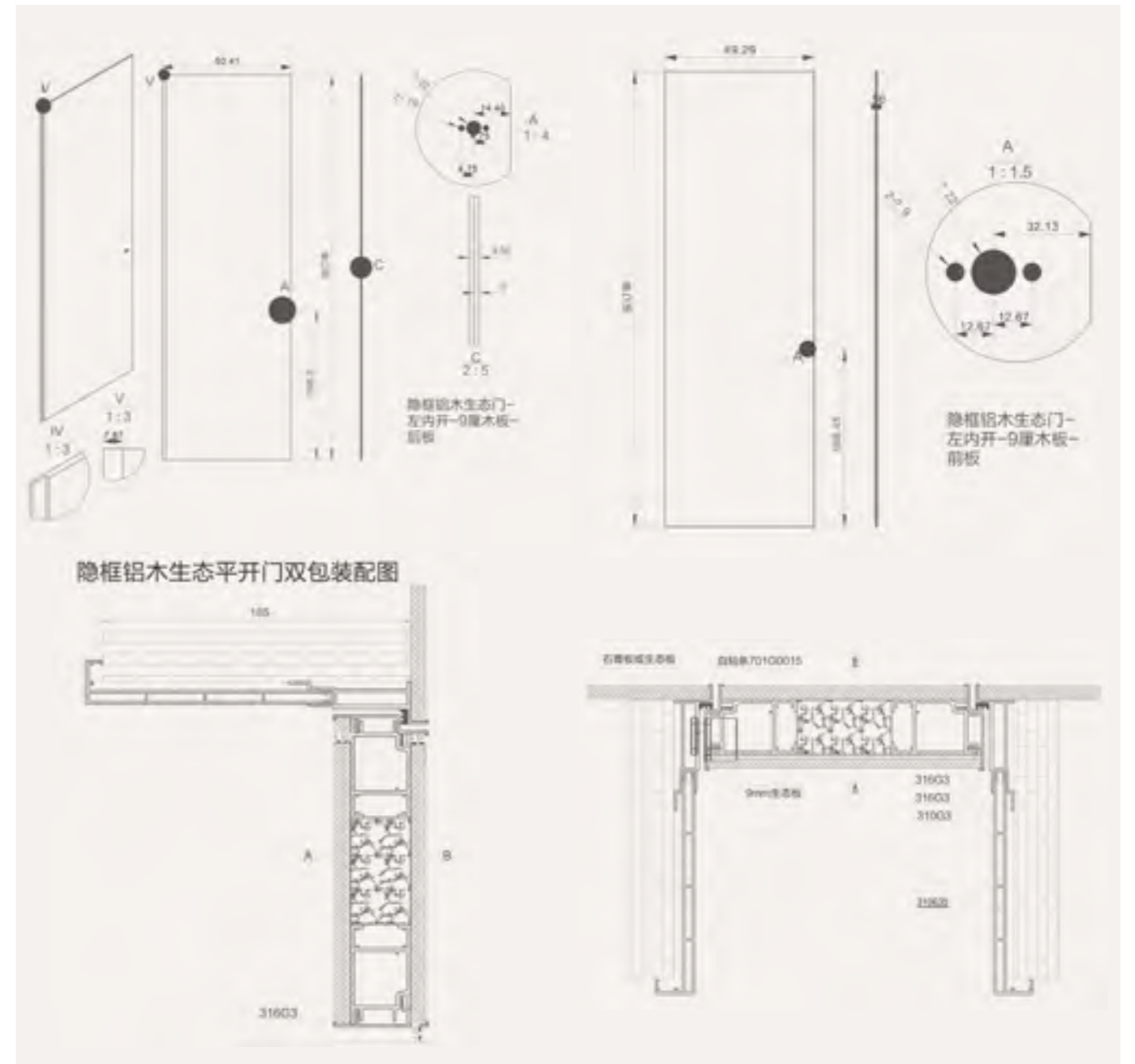

隐框铝木生态平开门双包装配图

G3292

竖框

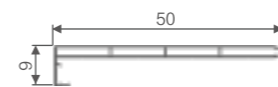

G3294

主框架

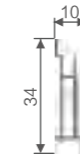

G3298

骨架



G3299

骨架扣盖

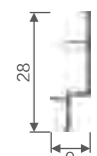

G3300

骨架扣盖

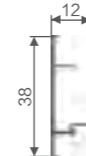

隐框玻璃门 - STM006



门套角码



门框角码



辅料角码



翘角铁片



极窄玻璃门 8 厘免外胶胶条



玻璃门下方镶缝胶条 (硅胶)



隐框平开门双包装配图(铝门套)

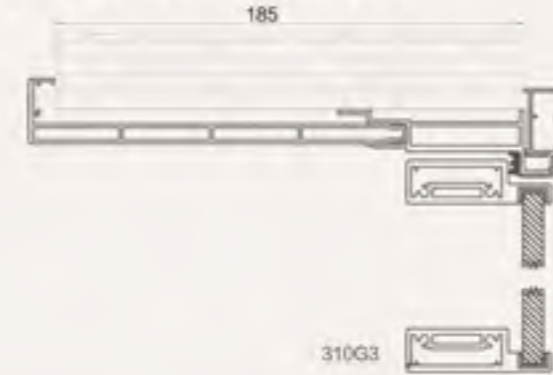

隐框平开门双包装配图(护墙板)

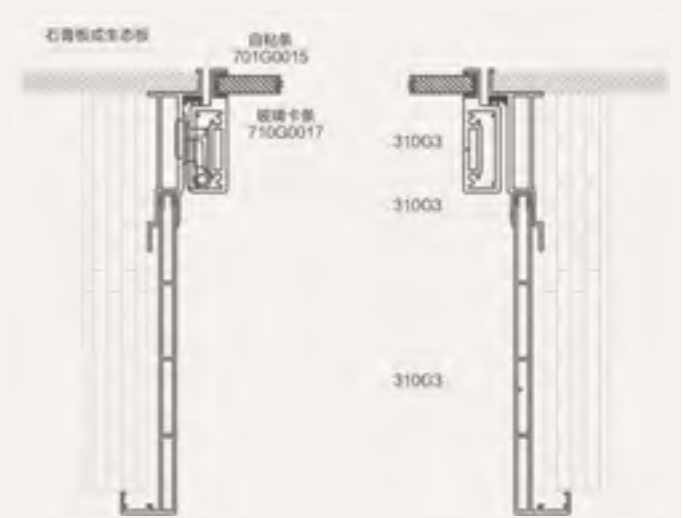
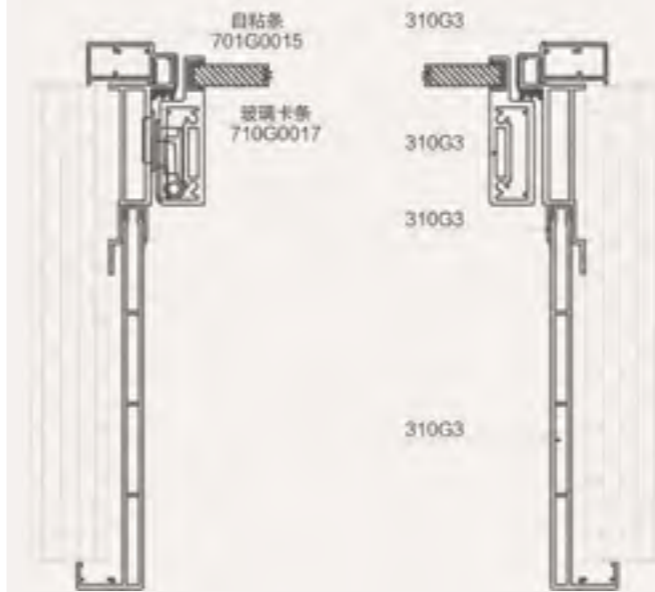

G3292



隐边斜边吊门 - STM007



G2976 专用角码



神州十一号 (209G0001)



G3244 斜边吊门隐边款左右侧框加



G2977 吊趟门上轨



斜边吊门隐边款上下横



格栅吊门 - STM008

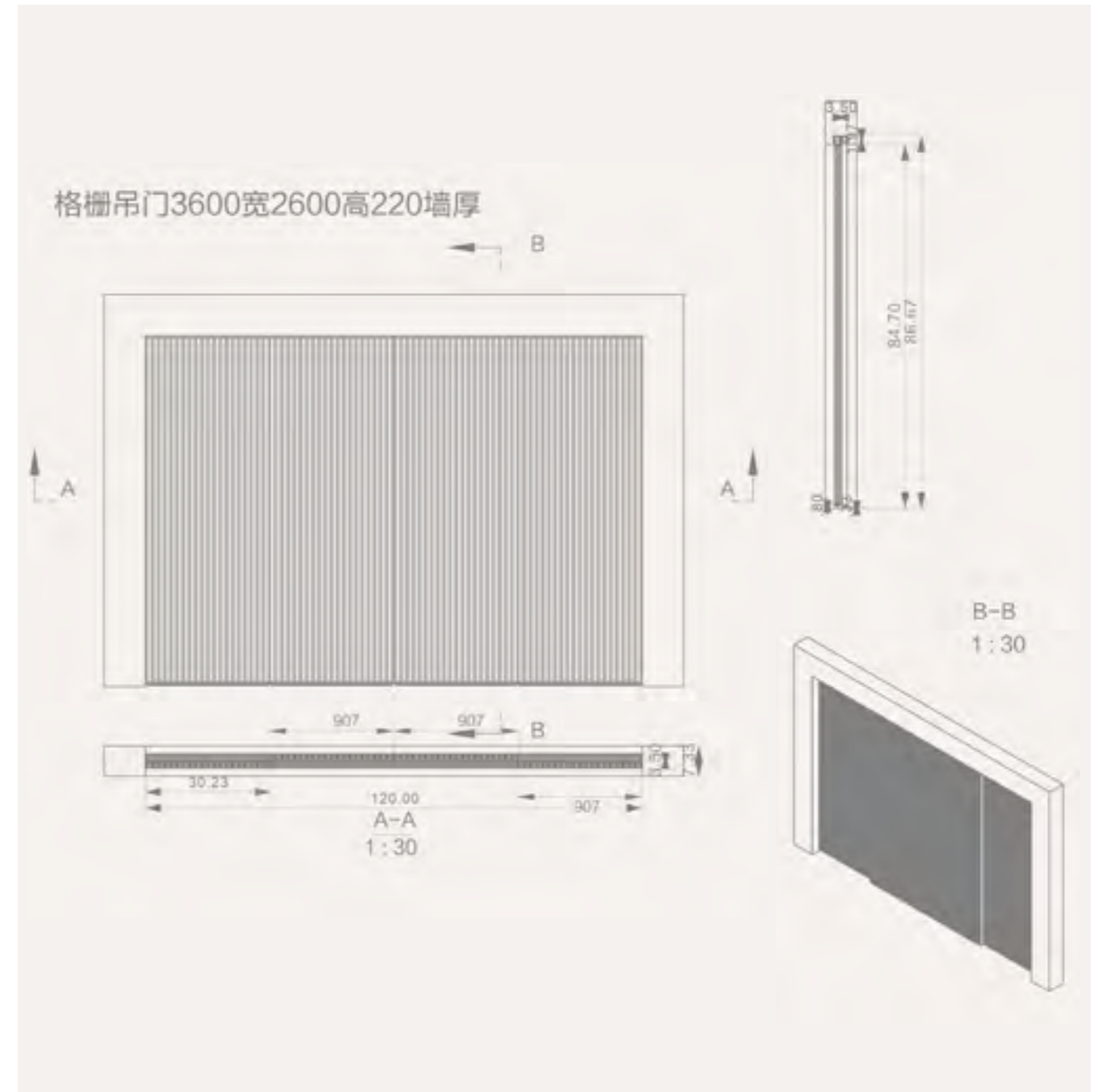

门套角码

神州十一号 (209G0001)



G3241 格栅吊门格栅条



G3242 格栅吊门上下框



G3243 侧框开料



K3242 上轨



可调节护墙系统 -STM010



电源 100W



灯带



延长线 (杜邦线)



木作墙体



墙体固定角码 G3272



对层板制成假墙体

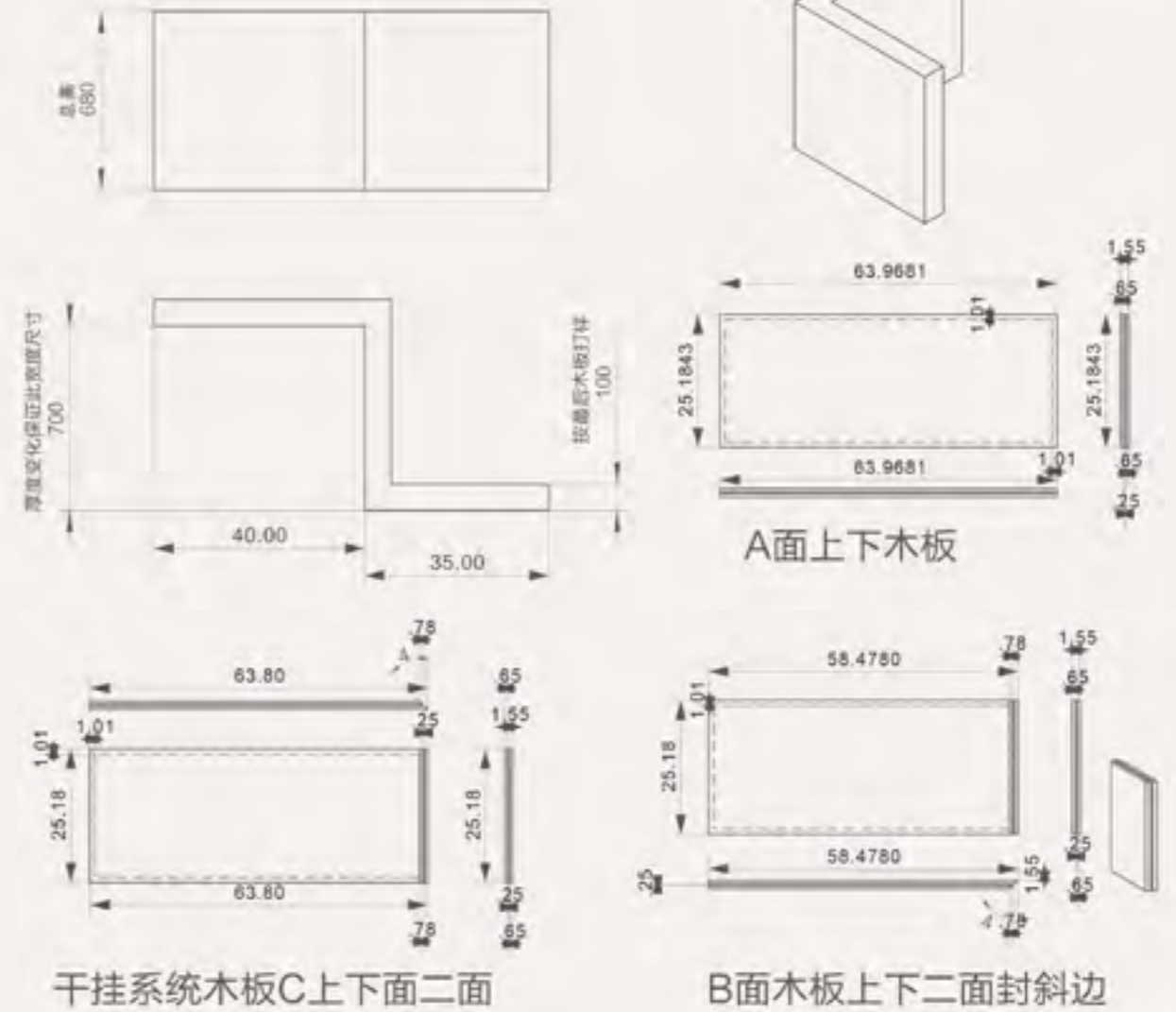

干挂式护墙 G3273 挂件 AC 下



干挂系统 G3274 上下灯条 /A 面顶底灯条 /上下灯条 B 面



干挂系统 G3276 置物架挂件 AB /挂件 AC



干挂系统 G3272 挂件 AB 下 /AB 上 / AC 面下 /A 上 /A 下



干挂系统置物架 G3277 挂件 B /挂件 BC





[极简屏风]

通过细腻而丰富的材质，
打造舒适而温馨的室内空间融合质朴的材质与低调中性的色彩，
带来一个极简而不是细节的家

序号	名称	图片
1	斜边屏风专用角码	 K3241
2	斜边屏风竖框	 K3239
3	斜边吊门上下横	 K3239
4	顶部固定件	 K1417
5	6*14内六角紧定螺丝	
6	5*8十字机丝	
7	ST4*30自攻丝	
8	斜边屏风专用胶条	

K3239

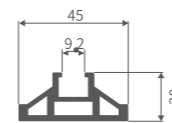

K3241

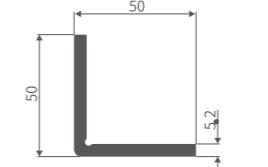

K1417

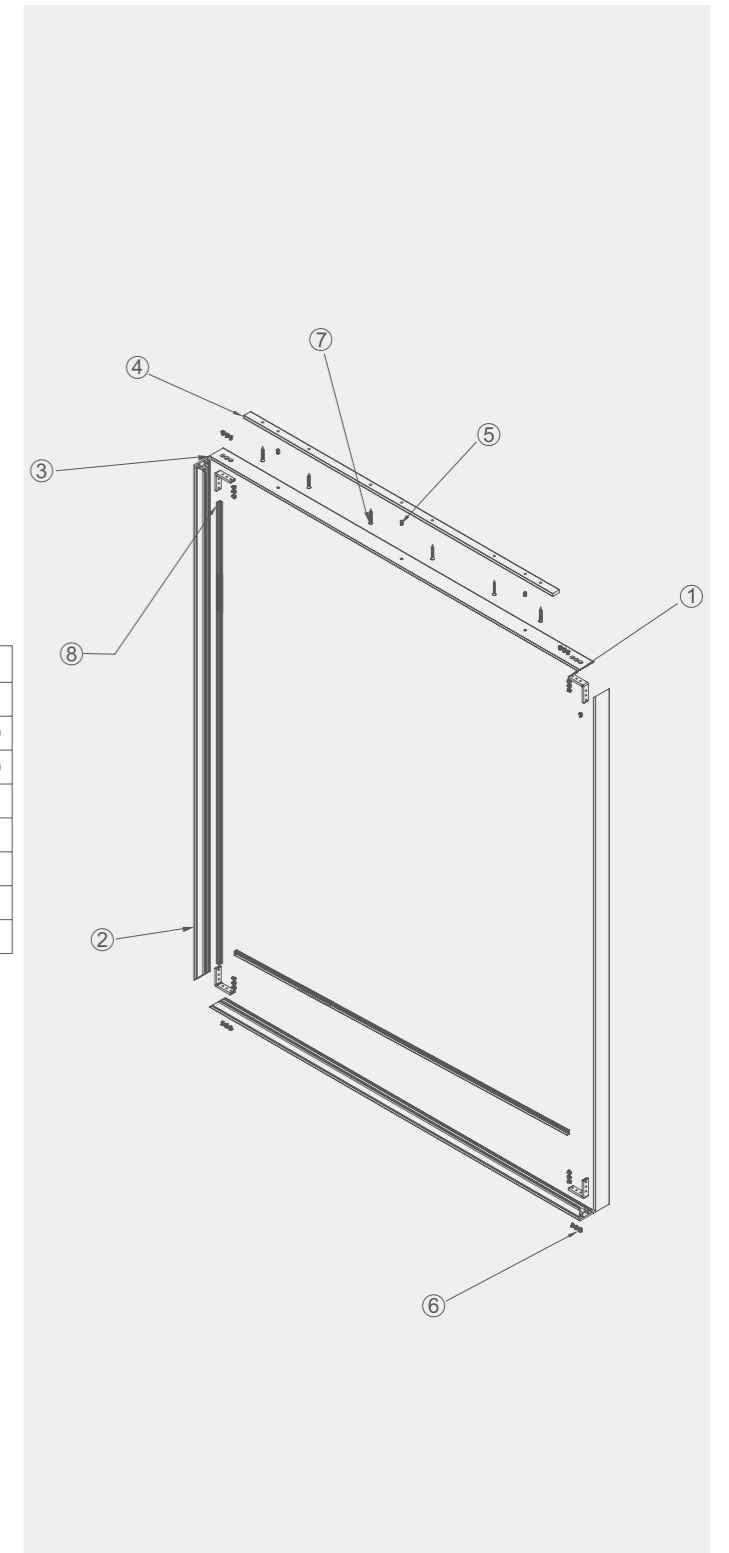
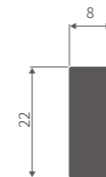

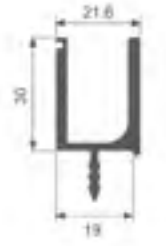

K3536



K3537



K3538

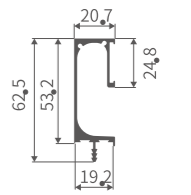

K1945

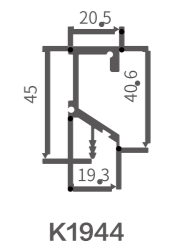
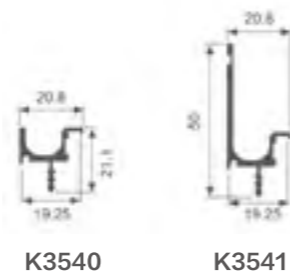
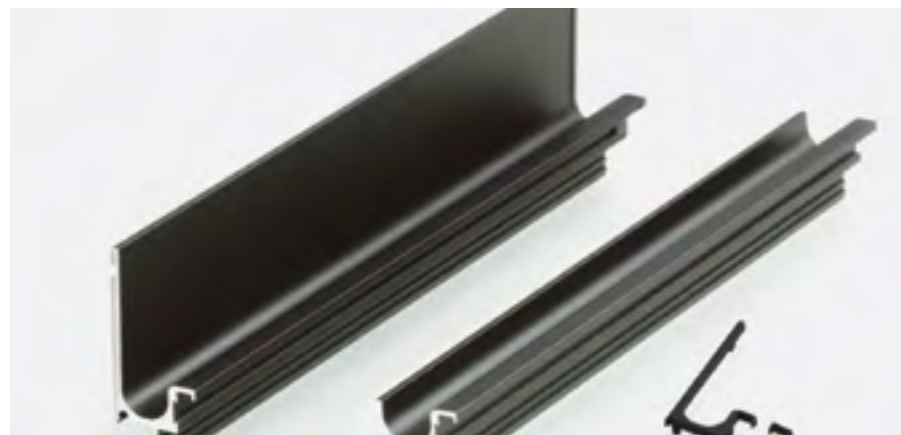
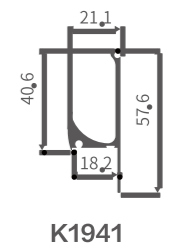
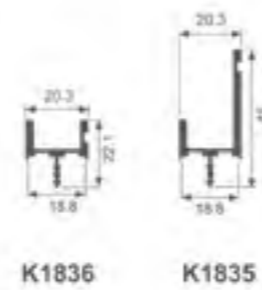
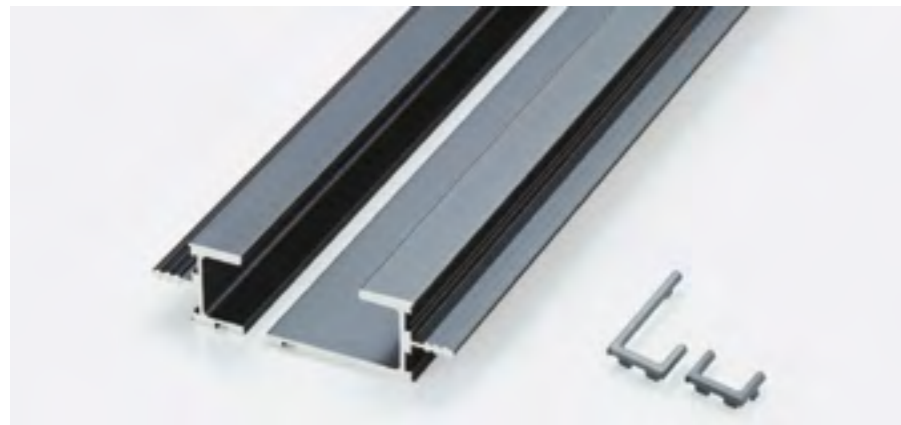
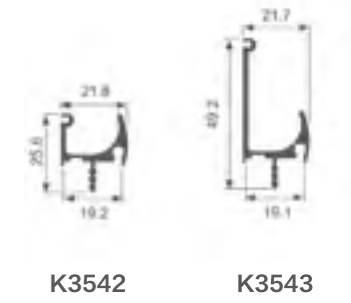
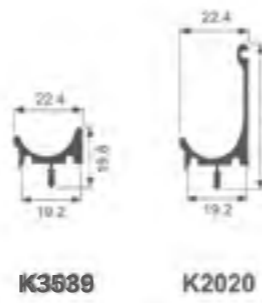
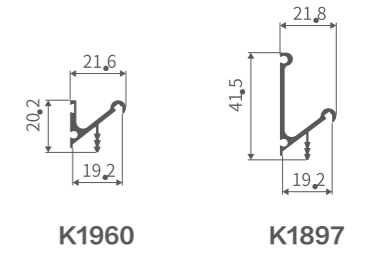
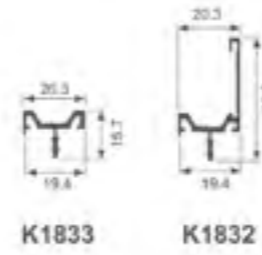



K2147

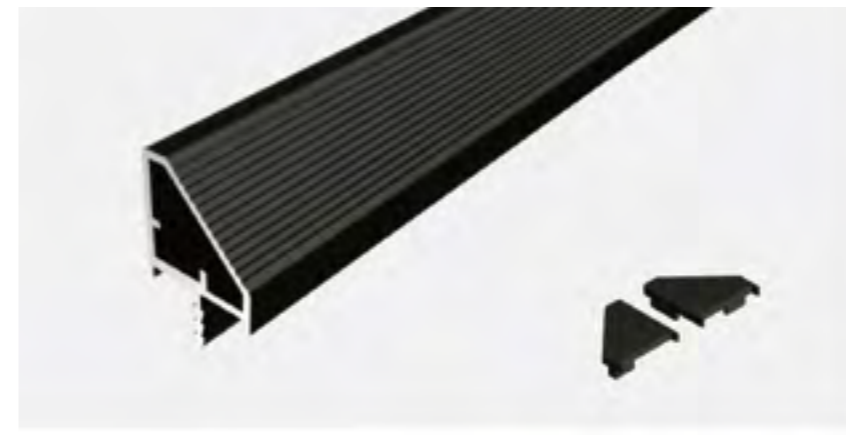

K3545

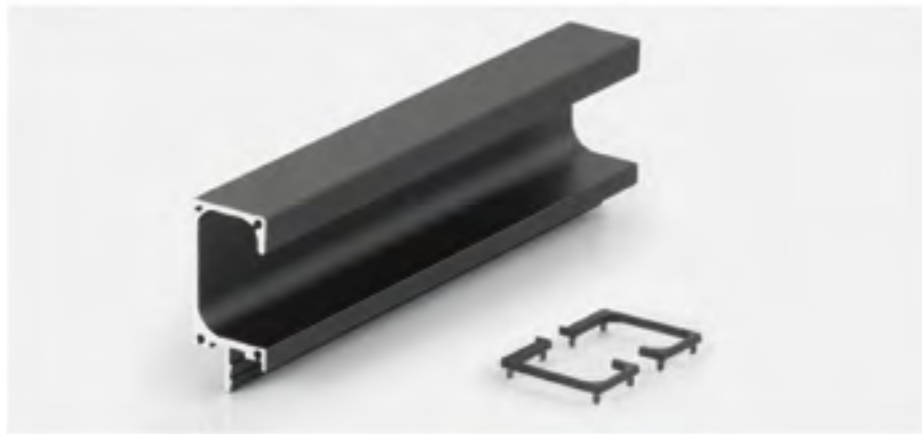

K383

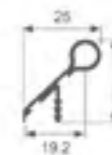

K3546

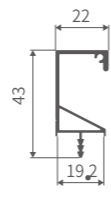

K1926

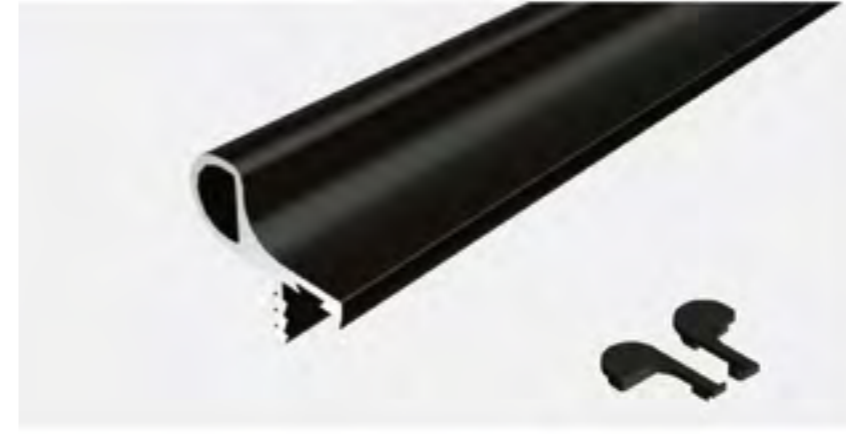

K3547



K3544

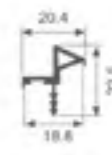

K3548

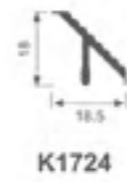
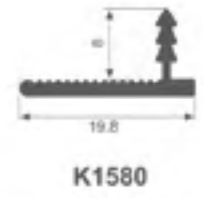
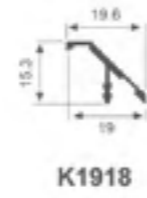
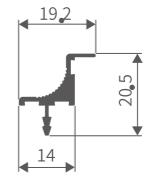
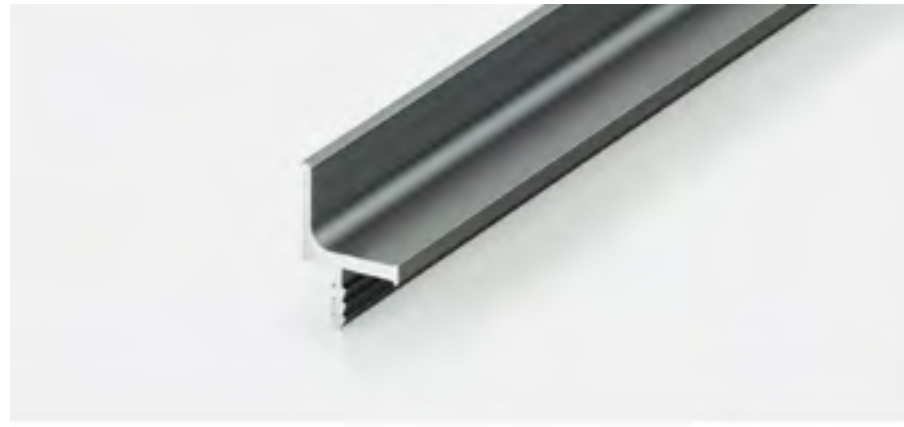

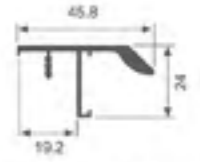

K3558 (皮革拇指款)

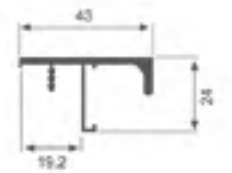

K3559 (皮革F款)

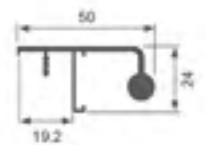

K3560



K3561

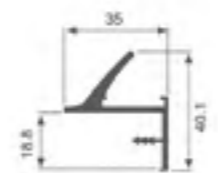

K3562

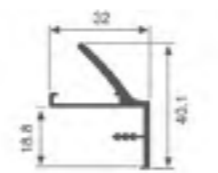

K3563



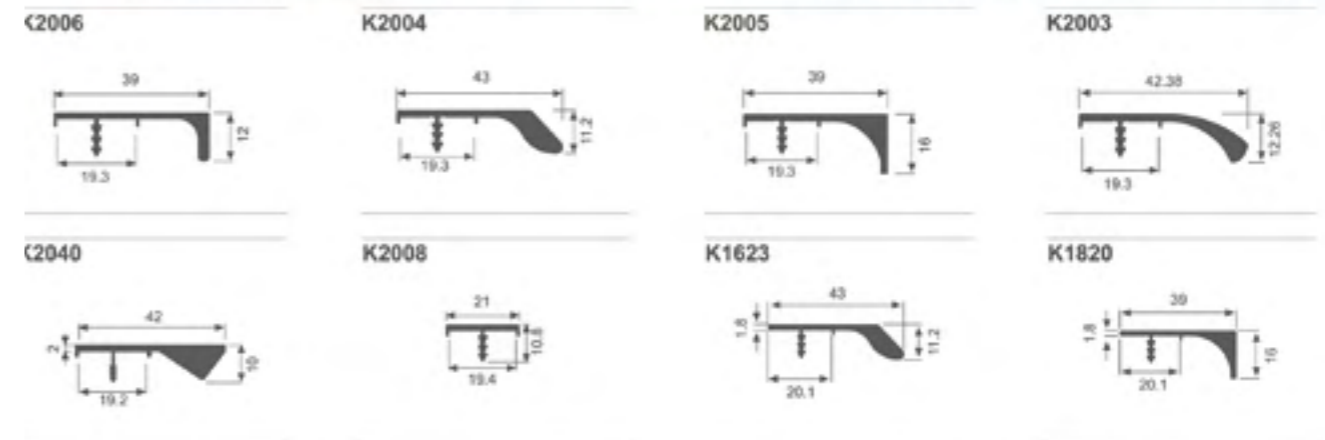
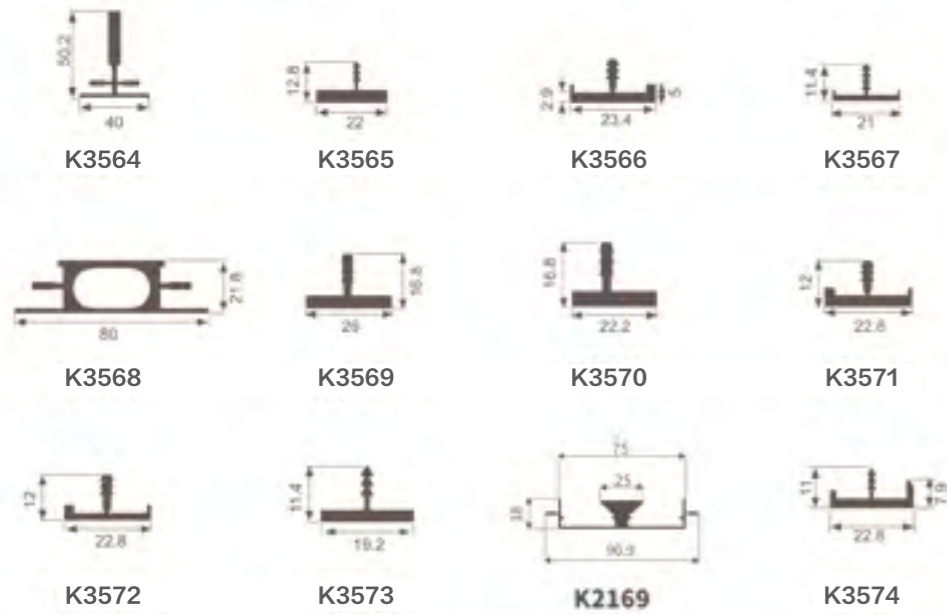

暗装拉手系列 *Concealed handle series*



K2015

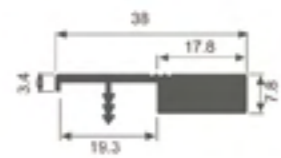

K2014

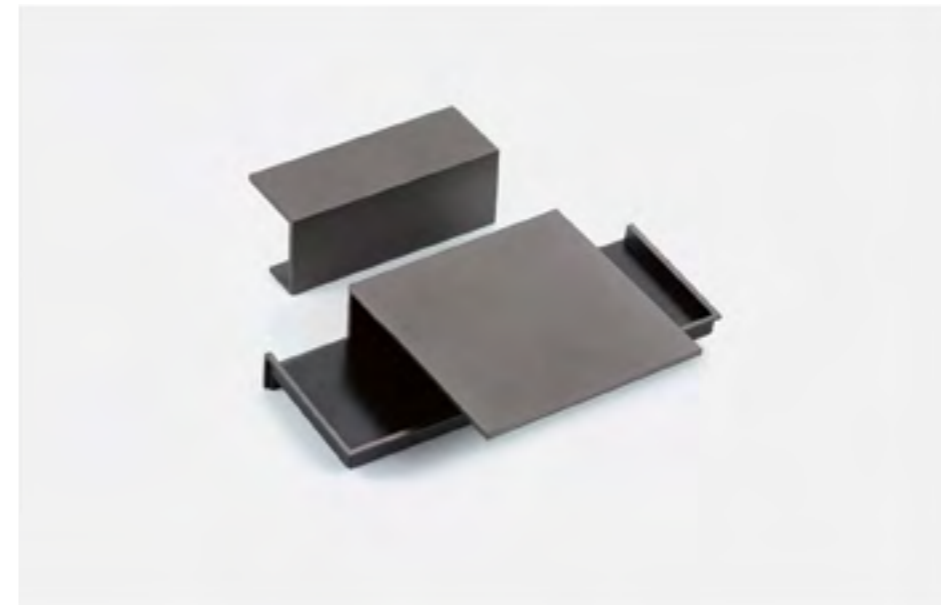
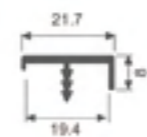

AC-13

外观尺寸

长度 (L)	宽度 (W)	高度 (H)
192	71.2	20

开槽尺寸

长度 (L)	宽度 (W)	深度 (H)
188	69	10

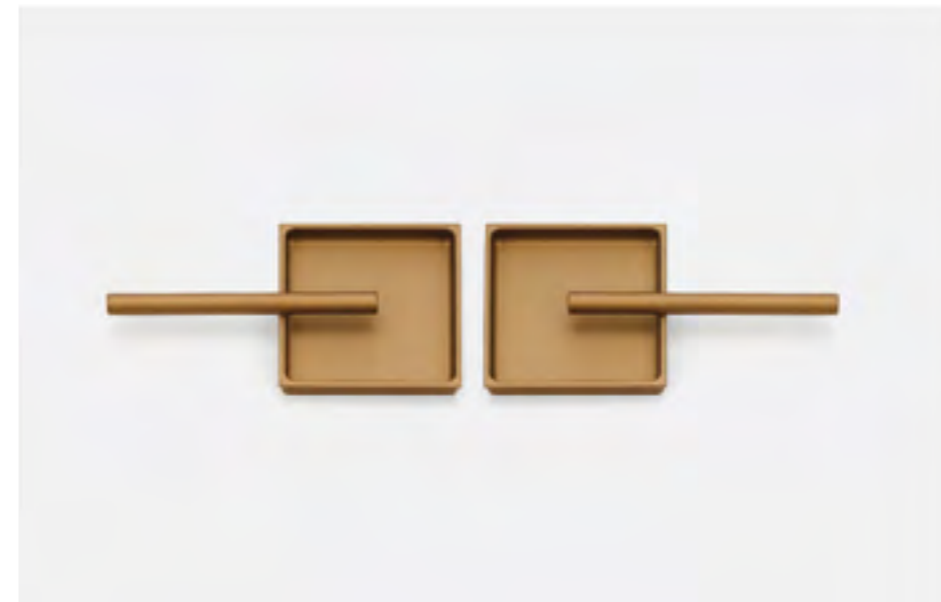

AC-10

外观尺寸

长度 (L)	宽度 (W)	高度 (H)
100	100	16

开槽尺寸

长度 (L)	宽度 (W)	深度 (H)
97	97	14.5



AC-35

外观尺寸

长度 (L)	宽度 (W)	高度 (H)
300	50	15

开槽尺寸

长度 (L)	宽度 (W)	深度 (H)
297	47	14

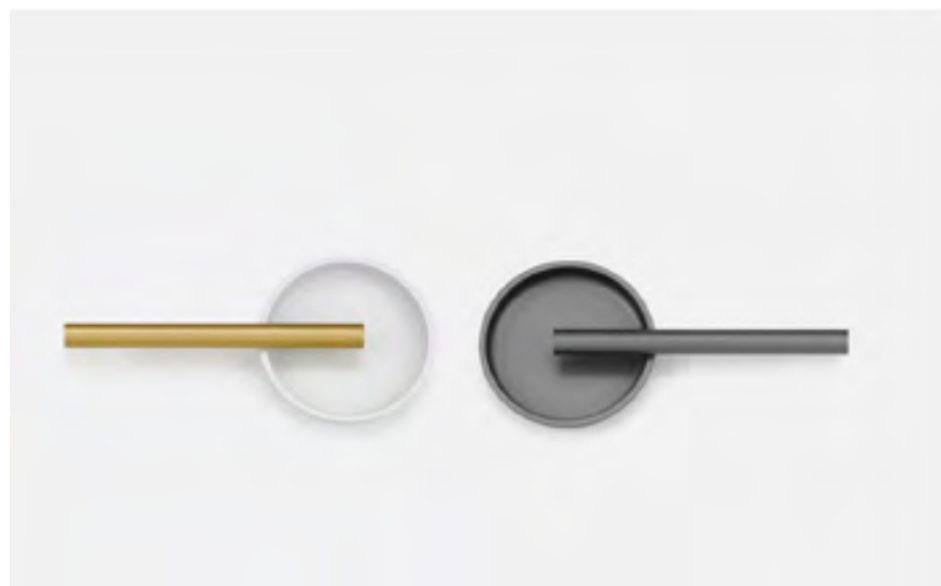

AC-09

外观尺寸

长度 (L)	宽度 (W)	高度 (H)
100		16

开槽尺寸

长度 (L)	宽度 (W)	深度 (H)
	98	14.5



AC-21

外观尺寸

长度 (L)	宽度 (W)	高度 (H)
180	50	19

开槽尺寸

长度 (L)	宽度 (W)	深度 (H)
176	46	13.5

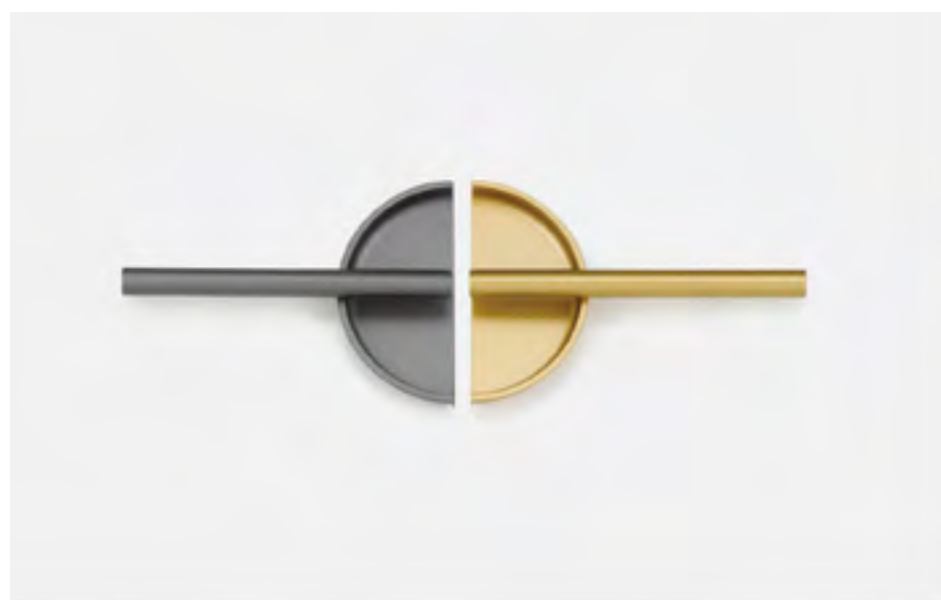

AC-11

外观尺寸

长度 (L)	宽度 (W)	高度 (H)
120		15

开槽尺寸

长度 (L)	宽度 (W)	深度 (H)
	117	14



AC-14

外观尺寸

长度 (L)	宽度 (W)	高度 (H)
200	29	30

开槽尺寸

长度 (L)	宽度 (W)	深度 (H)
198	28	15.5



AC-16A

外观尺寸

长度 (L)	宽度 (W)	高度 (H)
175	30.5	14

开槽尺寸

长度 (L)	宽度 (W)	深度 (H)
173	28	13



AC-18

外观尺寸

长度 (L)	宽度 (W)	高度 (H)
200	50	14

开槽尺寸

长度 (L)	宽度 (W)	深度 (H)
196	46	13



AC-19

外观尺寸

长度 (L)	宽度 (W)	高度 (H)
200	50	14

开槽尺寸

长度 (L)	宽度 (W)	深度 (H)
196	46	13



AC-15

外观尺寸

长度 (L)	宽度 (W)	高度 (H)
200	41	15

开槽尺寸

长度 (L)	宽度 (W)	深度 (H)
196	35	13.5



AC-03

外观尺寸

长度 (L)	宽度 (W)	高度 (H)
160	48	15

开槽尺寸

长度 (L)	宽度 (W)	深度 (H)
145	32	14

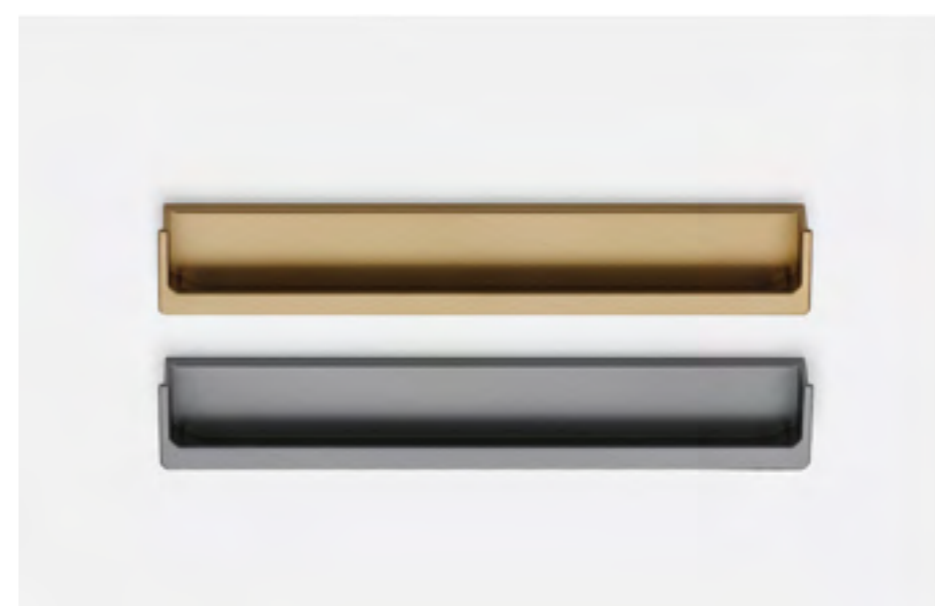

AC-17

外观尺寸

长度 (L)	宽度 (W)	高度 (H)
200	29	20

开槽尺寸

长度 (L)	宽度 (W)	深度 (H)
197	28	15



AC-22

外观尺寸

长度 (L)	宽度 (W)	高度 (H)
200	50	15

开槽尺寸

长度 (L)	宽度 (W)	深度 (H)
196	46	13.5



AC-34

外观尺寸

长度 (L)	宽度 (W)	高度 (H)
200	29	23

开槽尺寸

长度 (L)	宽度 (W)	深度 (H)
197.5	28	14



K211+K212 K213+K214



K1071 K291 K218

K211



壁厚: 22.5mm 重量: 0.362kg/m

K212

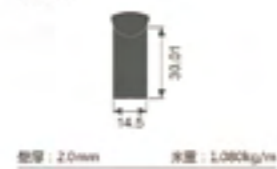

壁厚: 2.0mm 重量: 1.080kg/m

材质: 铝合金

长度与表面处理可定制
Material: Aluminium alloy The length and surface treatment may have custom made



K218



重量: 0.599kg/m

材质: 铝合金

长度与表面处理可定制
Material: Aluminium alloy The length and surface treatment may have custom made



K312 K600 K1111

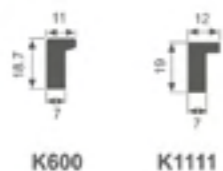

材质：铝合金

长度与表面处理可订制

Material: Aluminium alloy The length and surface treatment may have custom made

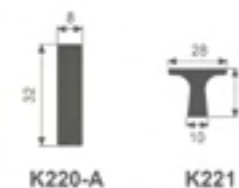

材质：铝合金

长度与表面处理可订制

Material: Aluminium alloy The length and surface treatment may have custom made



K220-A K1055 K221



K1406 (子弹头平头款)



长度(L)	孔距(C)	高度(H)	宽度(W)
220	192	28	10
1100	四孔	28	10
2400	八孔	28	10
2800	八孔	28	10



K1406-X (子弹头斜角款)



长度(L)	孔距(C)	高度(H)	宽度(W)
156	96	28	10
188	128	28	10
220	160	28	10
500	384	28	10
800	四孔	28	10
1000	四孔	28	10
1100	四孔	28	10



K220-A

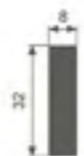

长度(L)	孔距(C)	高度(H)	宽度(W)
130	96	32	8
160	128	32	8
190	160	32	8
220	192	32	8
500	384	32	8
800		32	8
1000		32	8
1100		32	8



K219



长度(L)	孔距(C)	高度(H)	宽度(W)
116	96	30	17
148	128	30	17
216	192	30	17
276	256	30	17
500	384	30	17
1000	四孔	30	17
1100	四孔	30	17



K219-X



长度(L)	孔距(C)	高度(H)	宽度(W)
140	96	30	17
160	128	30	17
180	160	30	17
220	192	30	17
600	三孔	30	17
800	三孔	30	17
1000	三孔	30	17
1100	三孔	30	17



K1620



长度(L)	孔距(C)	高度(H)	宽度(W)
120	96	32	12
150	128	32	12
200	160	32	12
500	384	32	12
1000	三孔	32	12
1100	三孔	32	12
2440	八孔	32	12
2800	八孔	32	12

K-1670T



长度(L)	孔距(C)	宽度(W)	高度(H)
120	96	14.5	14
150	128	14.5	14
180	160	14.5	14
400	352	14.5	14
600	512	14.5	14
800	760	14.5	14
1000	960	14.5	14

K1534



长度(L)	孔距(C)	高度(H)	宽度(W)
80	64	21.2	14.58
120	96	21.2	14.58
150	128	21.2	14.58
220	192	21.2	14.58
500	384	21.2	14.58
1000	三孔	21.2	14.58

K218-X



长度(L)	孔距(C)	高度(H)	宽度(W)
160	96	35	8
190	128	35	8
220	160	35	8
280	224	35	8
400	352	35	8

K220-T



长度(L)	孔距(C)	高度(H)	宽度(W)
160	128	32	8
190	160	32	8
260	224	32	8
360	320	32	8

K1620-B (威法拉手)



长度(L)	孔距(C)	高度(H)	宽度(W)
150	128	32	12
220	160	32	12
500	384	32	12
800	四孔	32	12
1000	四孔	32	12
1100	四孔	32	12

K312-B



长度(L)	孔距(C)	高度(H)	宽度(W)
140	96	34	11
170	128	34	11
200	160	34	11
430	384	34	11
800	三孔	34	11
1000	四孔	34	11



K218-B



长度(L)	孔距(C)	高度(H)	宽度(W)
160	96	35	8
190	128	35	8
220	160	35	8
260	192	35	8
320	256	35	8
400	320	35	8



K1071



长度(L)	孔距(C)	高度(H)	宽度(W)
130	96	32	12
160	128	32	12
190	160	32	12
220	192	32	12
290	256	32	12
360	320	32	12



K312-C



长度(L)	孔距(C)	高度(H)	宽度(W)
220	160	34	11
500	384	34	11
1100	四孔	34	11



K291



长度(L)	孔距(C)	高度(H)	宽度(W)
130	96	27	11
160	128	27	11
190	160	27	11
222	192	27	11
320	256	27	11
380	320	27	11



K291



长度(L)	孔距(C)	高度(H)	宽度(W)
130	96	27	11
160	128	27	11
190	160	27	11
222	192	27	11
320	256	27	11
380	320	27	11



K1839



长度(L)	孔距(C)	高度(H)	宽度(W)
160	128	28.9	17.7
190	160	28.9	17.7



K218Y



长度(L)	孔距(C)	高度(H)	宽度(W)
170	128	35	8
202	160	35	8
266	128/224	35	8
362	128/320	35	8



K421-X

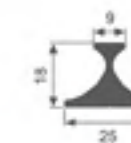

长度(L)	孔距(C)	高度(H)	宽度(W)
160	128	18	25
190	160	18	25
250	224	18	25
350	320	18	25



K1493



长度(L)	孔距(C)	高度(H)	宽度(W)
160	128	20	30
190	160	20	30
260	224	20	30
360	320	20	30



K421

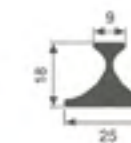

长度(L)	孔距(C)	高度(H)	宽度(W)
220	128	18	25
250	160	18	25
320	224	18	25
420	320	18	25



K1838



长度(L)	孔距(C)	高度(H)	宽度(W)
160	128	28.5	17
190	160	28.5	17
250	224	28.5	17
320	350	28.5	17



K1228



长度(L)	孔距(C)	高度(H)	宽度(W)
228	128	23	17.5
260	160	23	17.5
324	224	23	17.5
420	320	23	17.5
1200	544±2	23	17.5



K221-X



长度	孔距
45	32
120	96
150	128
180	160
1000	960



K1928



长度	孔距
160	128
200	160
1000	960



K1926 铝片免拉手



长度	孔距
200	
300	
1100	
2750	



K1929



长度	孔距
160	128
200	160
1000	960



K1391 弧形拉手



长度	孔距
400	320
600	三孔
800	四孔
1100	五孔



K1927



长度	孔距
160	128
200	160
1000	960

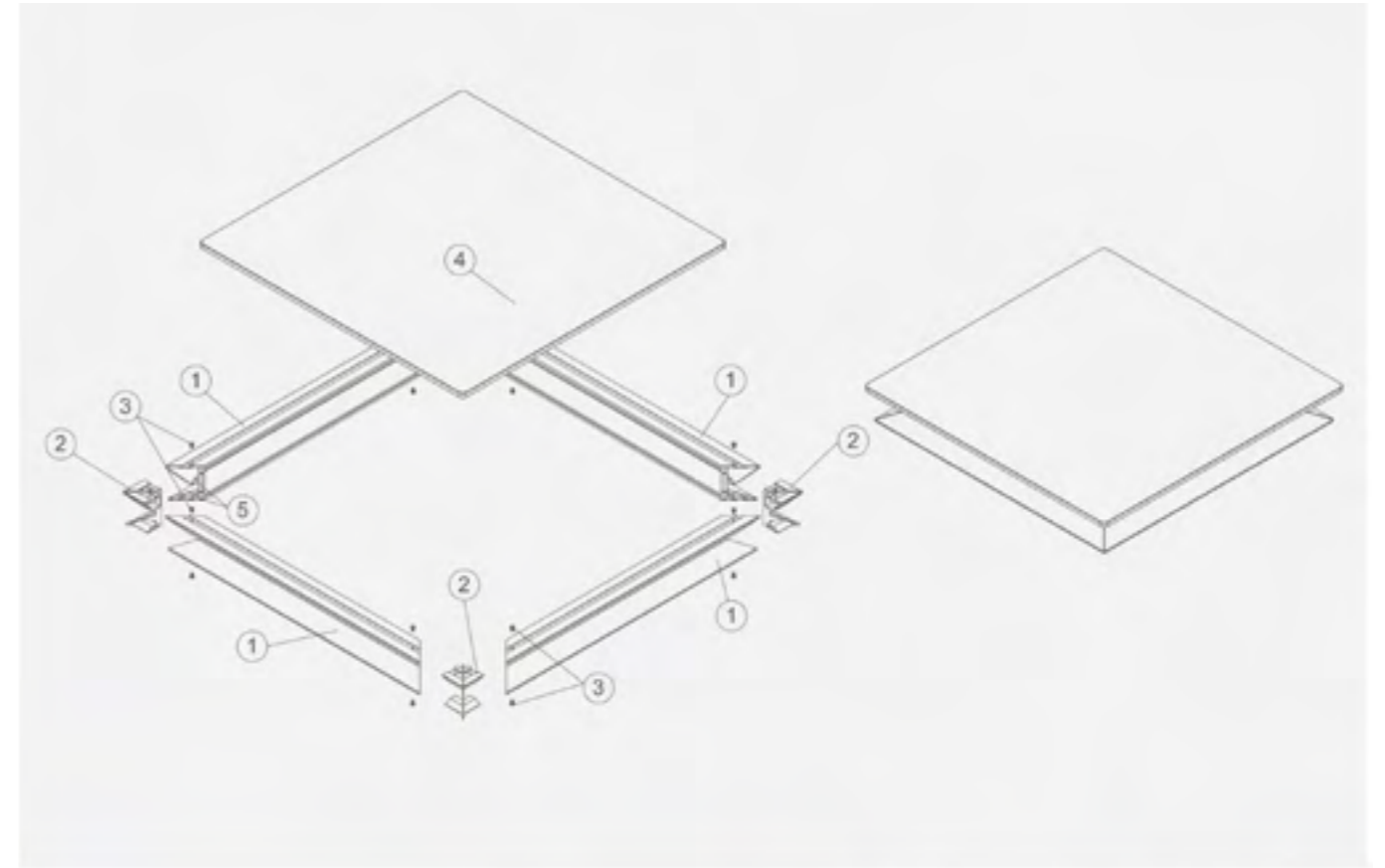

序号	名称	图片
1	型材	 K3576
2	铝合金连接角码	
3	M4x10圆头机丝	
4	台板	
5	灯盖胶	





双面发光吊柜底板灯

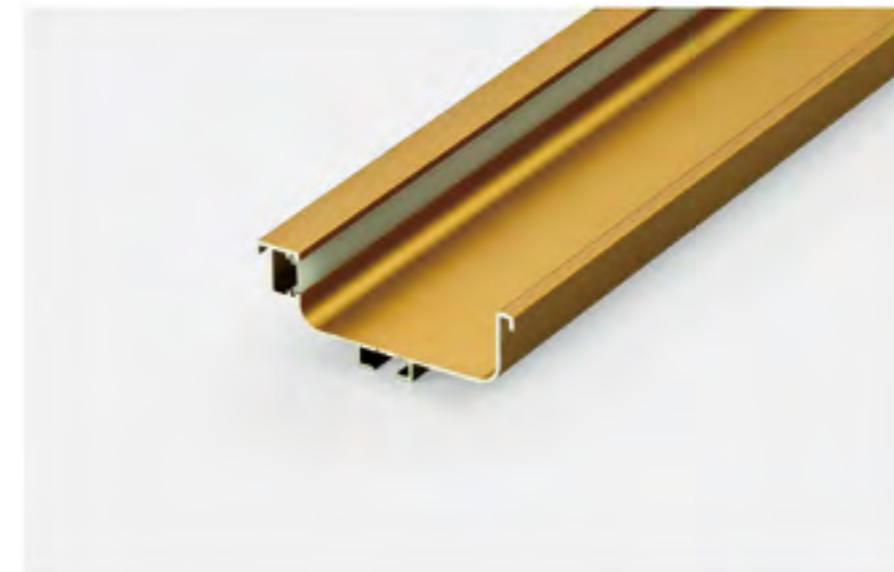

带灯橱柜中柜免拉手

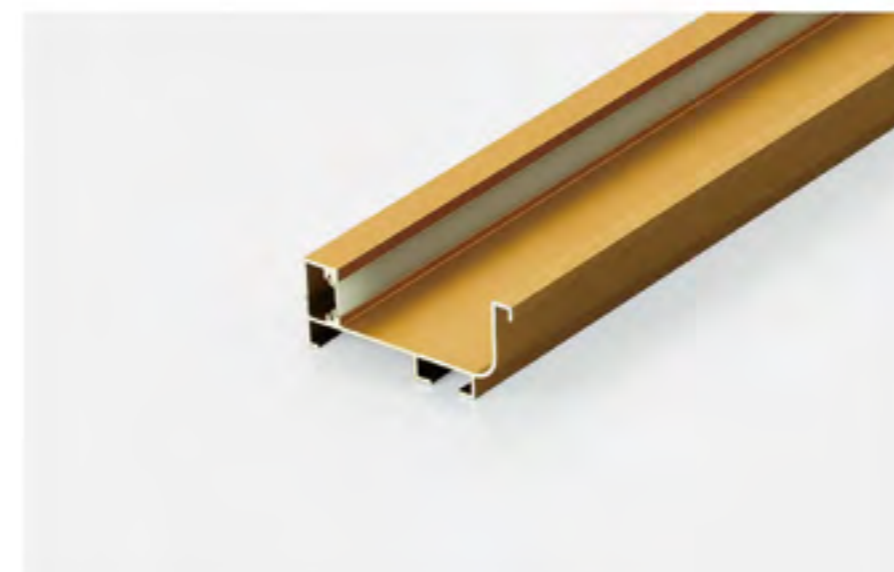
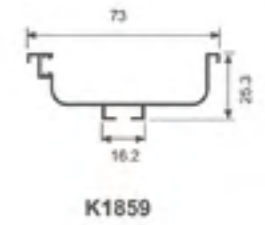

带灯橱柜下柜免拉手

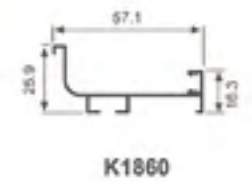

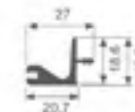
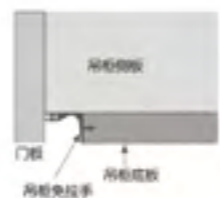

A30-38

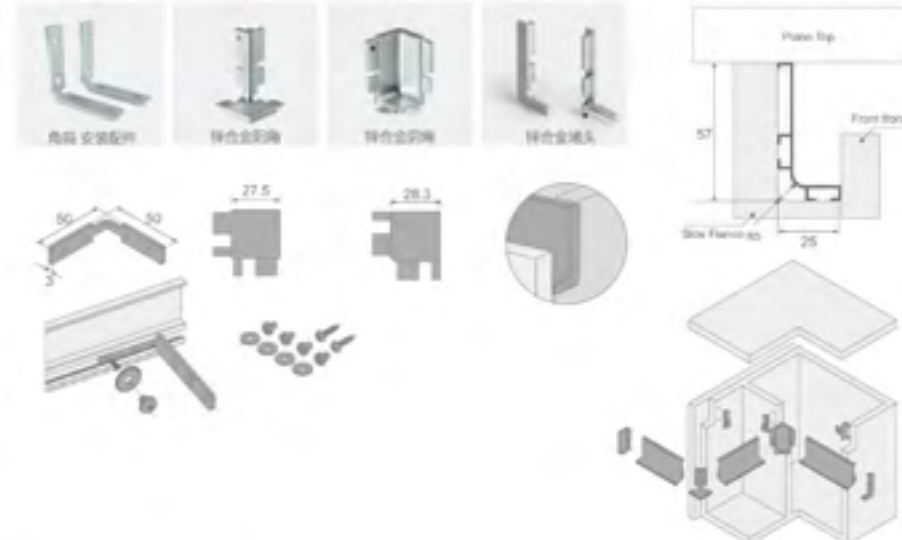
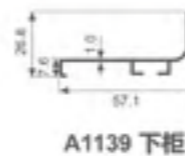
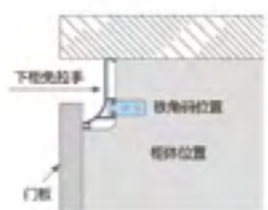
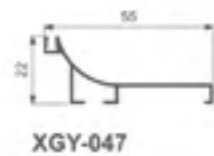
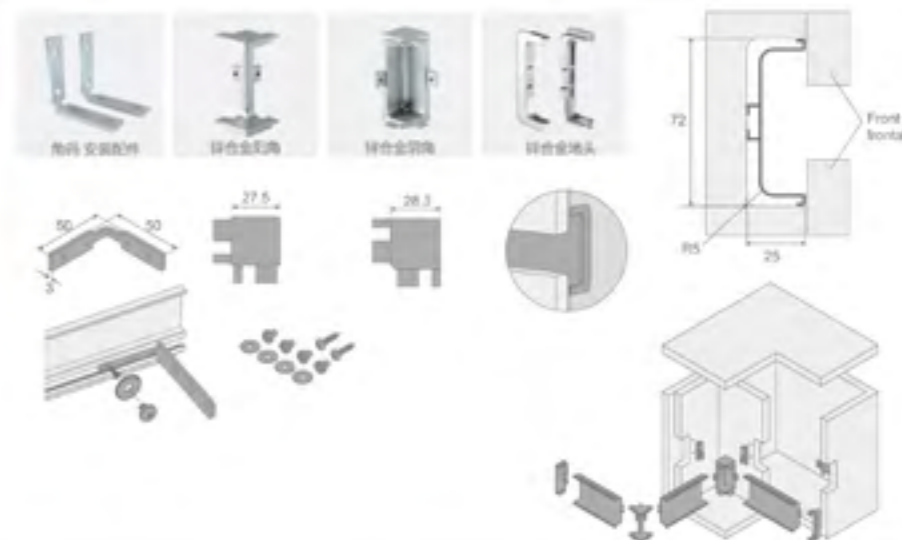
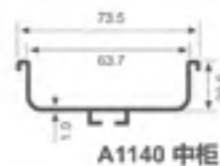
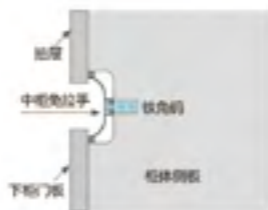
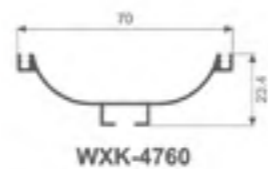
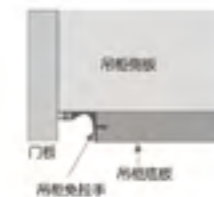



橱柜、衣柜脚线灯

Cupboard & wardrobe foot line lamp

特点：有效解决橱柜、衣柜脚下阴影和照明效果，使柜体更加美观、时尚，而且防潮防霉、防水功能。
 尺寸：长度可定制
 功率：9.5W/米
 电压：12VDC
 色温光源：3000K、4000K、6000K
 开关方式：外接开关
 驱动方式：恒压驱动
 可选颜色：暖黄、古铜拉丝、铁灰拉丝



K3148
K3148



中连接码
P100

大转角
P101

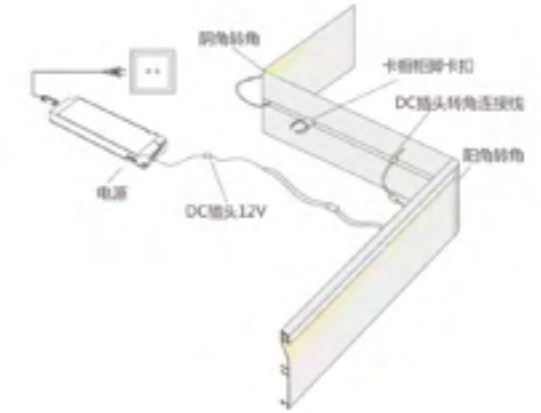
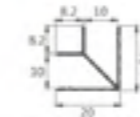

弧形橱柜脚线灯

Arc cabinet footline lamp

特点：有效解决橱柜、衣柜脚下阴影和照明效果，使柜体更加美观、时尚，而且防潮防霉、防水功能。
 尺寸：长度定制 高度100mm
 色温光源：暖光WW: 3000K、暖光WW: 4000K、白光CW: 6500K、蓝光 10W/米
 供电：DC-12V (适配器外置)
 开关方式：无线开关、人体感应开关、微波感应开关
 材料：优质铝材、PC、PU胶 (铁灰、金色)
 订购方式：非标定制

K2153

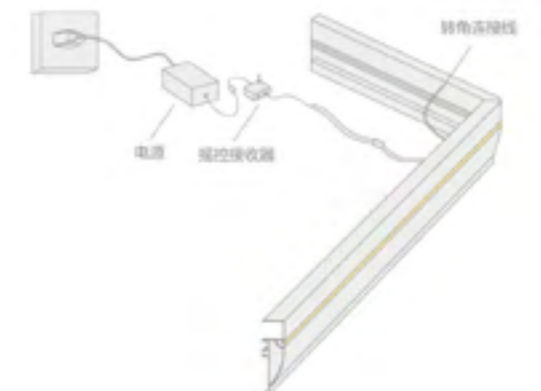
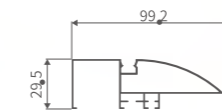

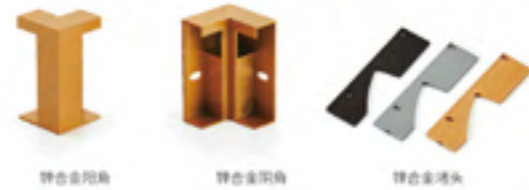
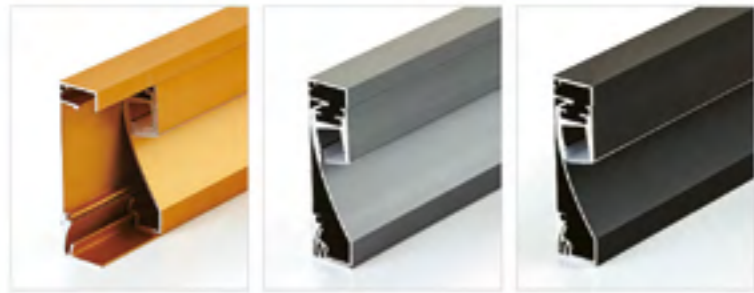

铝合金角

铝合金角

铝合金头

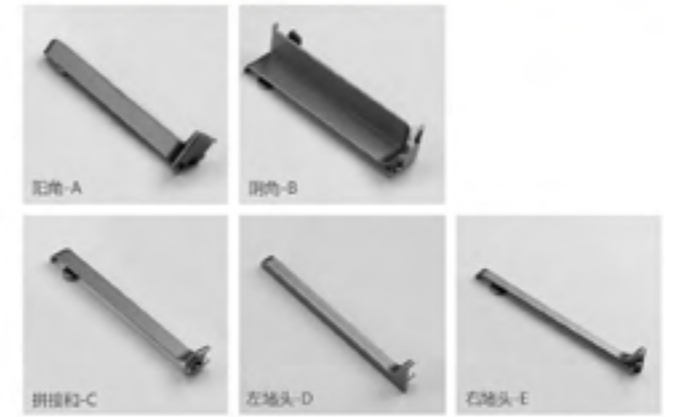

铝角-A

铝角-B

拼接扣-C

左端头-D

右端头-E

K3580

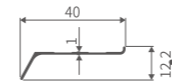

K3581

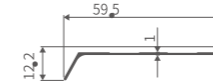

K3582

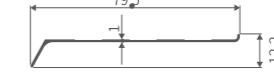

K3583

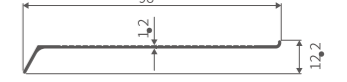



威法款拉直器
Weifa straightener

主要材质铝合金
表面处理拉丝威法金/铁灰/铂黑
Material Aluminum alloy
Finish Brushed Weifa gold / Iron ash / matte black

K1819

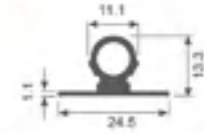

厚度: 1.2mm 重量: 0.221kg/m



拉直器规格长度(Size): 1.5m / 1.8m / 2.1m / 2.44m / 2.8m



威法款拉直器
Weifa straightener

主要材质铝合金
表面处理拉丝威法金/铁灰/铂黑
Material Aluminum alloy
Finish Brushed Weifa gold / Iron ash / matte black

K1816

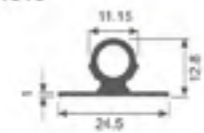



厚度: 1.0mm 重量: 0.206kg/m



拉直器规格长度(Size): 1.5m / 1.8m / 2.1m / 2.44m / 2.8m

<p>K1027</p> <p>壁厚: 1.8mm 米重: 0.41kg/m</p>	<p>K1028</p> <p>壁厚: 1.8mm 米重: 0.55kg/m</p>	<p>K1067</p> <p>壁厚: 1.5mm 米重: 0.45kg/m</p>	<p>K1068</p> <p>壁厚: 1.5mm 米重: 0.67kg/m</p>	<p>K1825</p> <p>壁厚: 1.2mm 米重: 0.24kg/m</p>	<p>K1826</p> <p>壁厚: 1.2mm 米重: 0.35kg/m</p>	<p>K2080</p> <p>壁厚: 1.8mm 米重: 0.56kg/m</p>	<p>K2082</p> <p>壁厚: 1.8mm 米重: 0.72kg/m</p>	
<p>K1069</p> <p>壁厚: 1.6mm 米重: 0.67kg/m</p>	<p>K1070</p> <p>壁厚: 1.6mm 米重: 0.82kg/m</p>	<p>K1268</p> <p>壁厚: 2.8mm 米重: 0.82kg/m</p>	<p>K1269</p> <p>壁厚: 2.8mm 米重: 1.22kg/m</p>	<p>K2093</p> <p>壁厚: 2.8mm 米重: 1.22kg/m</p>	<p>K2094</p> <p>壁厚: 2.5mm 米重: 0.82kg/m</p>	<p>K3118</p> <p>壁厚: 2.6mm 米重: 0.38kg/m</p>	<p>K3119</p> <p>壁厚: 2.6mm 米重: 0.45kg/m</p>	
<p>K1449</p> <p>米重: 0.60kg/m</p>	<p>K1450</p> <p>壁厚: 1.2mm 米重: 0.54kg/m</p>	<p>K1451</p> <p>米重: 0.60kg/m</p>	<p>K1452</p> <p>壁厚: 1.5mm 米重: 0.51kg/m</p>	<p>G型拉手系列</p>		<p>K205</p> <p>壁厚: 1.5mm 米重: 0.99kg/m</p>	<p>K206</p> <p>壁厚: 1.8mm 米重: 0.81kg/m</p>	<p>K240</p> <p>壁厚: 1.3mm 米重: 0.71kg/m</p>
<p>K1453</p> <p>壁厚: 1.5mm 米重: 0.68kg/m</p>	<p>K1532</p> <p>壁厚: 1.8mm 米重: 0.38kg/m</p>	<p>K1533</p> <p>壁厚: 1.8mm 米重: 0.39kg/m</p>	<p>K1536</p> <p>壁厚: 2.0mm 米重: 0.40kg/m</p>	<p>K241</p> <p>壁厚: 1.5mm 米重: 0.39kg/m</p>	<p>K242</p> <p>壁厚: 1.5mm 米重: 0.58kg/m</p>	<p>K243</p> <p>壁厚: 1.5mm 米重: 0.42kg/m</p>	<p>K244</p> <p>壁厚: 1.5mm 米重: 0.59kg/m</p>	
<p>K1537</p> <p>壁厚: 2.0mm 米重: 0.34kg/m</p>	<p>K1581</p> <p>壁厚: 2.5mm 米重: 0.86kg/m</p>	<p>K1582</p> <p>壁厚: 2.5mm 米重: 0.69kg/m</p>	<p>K1706</p> <p>壁厚: 1.9mm 米重: 0.52kg/m</p>	<p>K245</p> <p>壁厚: 1.5mm 米重: 0.36kg/m</p>	<p>K246</p> <p>壁厚: 1.5mm 米重: 0.24kg/m</p>	<p>K248</p> <p>壁厚: 1.3mm 米重: 0.44kg/m</p>	<p>K249</p> <p>壁厚: 1.3mm 米重: 0.76kg/m</p>	
<p>K1707</p> <p>米重: 0.40kg/m</p>	<p>K1780</p> <p>壁厚: 1.2mm 米重: 0.93kg/m</p>	<p>K1744</p> <p>壁厚: 1.9mm 米重: 0.47kg/m</p>	<p>K1745</p> <p>壁厚: 1.9mm 米重: 0.37kg/m</p>	<p>K250</p> <p>壁厚: 0.96mm 米重: 0.30kg/m</p>	<p>K251</p> <p>壁厚: 1.5mm 米重: 0.44kg/m</p>	<p>K252</p> <p>壁厚: 2.0mm 米重: 0.60kg/m</p>	<p>K287</p> <p>壁厚: 2.6mm 米重: 0.48kg/m</p>	
<p>K1747</p> <p>壁厚: 2.1mm 米重: 0.53kg/m</p>	<p>K1748</p> <p>壁厚: 2.1mm 米重: 0.42kg/m</p>	<p>K1600</p> <p>壁厚: 2.1mm 米重: 0.62kg/m</p>	<p>K1601</p> <p>壁厚: 2.1mm 米重: 0.44kg/m</p>	<p>K309</p> <p>壁厚: 1.2mm 米重: 0.44kg/m</p>	<p>K310</p> <p>壁厚: 1.2mm 米重: 0.36kg/m</p>	<p>K313</p> <p>壁厚: 1.8mm 米重: 0.58kg/m</p>	<p>K314</p> <p>壁厚: 1.8mm 米重: 0.25kg/m</p>	

<p>K315</p> <p>壁厚: 1.0mm 重量: 0.548kg/m</p>	<p>K316</p> <p>壁厚: 2.8mm 重量: 0.349kg/m</p>	<p>K319</p> <p>壁厚: 2.0mm 重量: 0.290kg/m</p>	<p>K320</p> <p>壁厚: 1.5mm 重量: 0.180kg/m</p>	<p>K662</p> <p>壁厚: 5.5mm 重量: 0.227kg/m</p>	<p>K663</p> <p>壁厚: 0.55mm 重量: 0.053kg/m</p>	<p>K664</p> <p>壁厚: 0.3mm 重量: 0.101kg/m</p>	<p>K665</p> <p>壁厚: 1.05mm 重量: 0.348kg/m</p>
<p>K340</p> <p>壁厚: 2.7mm 重量: 0.365kg/m</p>	<p>K341</p> <p>壁厚: 2.7mm 重量: 0.354kg/m</p>	<p>K342</p> <p>壁厚: 2.64mm 重量: 0.364kg/m</p>	<p>K346</p> <p>壁厚: 1.3mm 重量: 0.249kg/m</p>	<p>K707</p> <p>壁厚: 2.0mm 重量: 0.254kg/m</p>	<p>K944</p> <p>壁厚: 1.5mm 重量: 0.413kg/m</p>	<p>K945</p> <p>壁厚: 1.1mm 重量: 0.418kg/m</p>	<p>K949</p> <p>壁厚: 1.8mm 重量: 0.534kg/m</p>
<p>K347</p> <p>壁厚: 2.75mm 重量: 0.378kg/m</p>	<p>K350</p> <p>壁厚: 1.31mm 重量: 0.409kg/m</p>	<p>K360</p> <p>壁厚: 1.2mm 重量: 0.414kg/m</p>	<p>K361</p> <p>壁厚: 0.8mm 重量: 0.106kg/m</p>	<p>K950</p> <p>壁厚: 1.5mm 重量: 0.492kg/m</p>	<p>K971</p> <p>壁厚: 1.5mm 重量: 0.730kg/m</p>	<p>K972</p> <p>壁厚: 2.0mm 重量: 0.622kg/m</p>	<p>K973</p> <p>壁厚: 1.5mm 重量: 0.548kg/m</p>
<p>K383</p> <p>壁厚: 2.0mm 重量: 0.607kg/m</p>	<p>K411</p> <p>壁厚: 1.4mm 重量: 0.638kg/m</p>	<p>K429</p> <p>壁厚: 1.1mm 重量: 0.391kg/m</p>	<p>K430</p> <p>壁厚: 0.7mm 重量: 0.070kg/m</p>	<p>K975</p> <p>壁厚: 2.0mm 重量: 0.767kg/m</p>	<p>K1058</p> <p>壁厚: 2.6mm 重量: 0.779kg/m</p>	<p>K1066</p> <p>壁厚: 1.2mm 重量: 0.426kg/m</p>	<p>K1121</p> <p>壁厚: 2.0mm 重量: 0.639kg/m</p>
<p>K431</p> <p>壁厚: 1.0mm 重量: 0.391kg/m</p>	<p>K432</p> <p>壁厚: 0.7mm 重量: 0.094kg/m</p>	<p>K433</p> <p>壁厚: 1.0mm 重量: 0.325kg/m</p>	<p>K434</p> <p>壁厚: 1.2mm 重量: 0.096kg/m</p>	<p>K1134</p> <p>壁厚: 1.1mm 重量: 0.317kg/m</p>	<p>K1136</p> <p>壁厚: 0.6mm 重量: 0.059kg/m</p>	<p>K1144</p> <p>壁厚: 2.6mm 重量: 0.483kg/m</p>	<p>K1145</p> <p>壁厚: 1.2mm 重量: 0.382kg/m</p>
<p>K510</p> <p>壁厚: 1.8mm 重量: 0.582kg/m</p>	<p>K584</p> <p>壁厚: 1.9mm 重量: 0.607kg/m</p>	<p>K585</p> <p>壁厚: 1.1mm 重量: 0.379kg/m</p>	<p>K586</p> <p>壁厚: 0.7mm 重量: 0.082kg/m</p>	<p>K1183</p> <p>壁厚: 1.5mm 重量: 0.316kg/m</p>	<p>K1184</p> <p>壁厚: 1.5mm 重量: 0.249kg/m</p>	<p>K1189</p> <p>壁厚: 1.8mm 重量: 0.791kg/m</p>	<p>K1243</p> <p>壁厚: 2.0mm 重量: 0.487kg/m</p>
<p>K602</p> <p>壁厚: 1.2mm 重量: 0.463kg/m</p>	<p>K643</p> <p>壁厚: 1.9mm 重量: 0.598kg/m</p>	<p>K644</p> <p>壁厚: 1.4mm 重量: 0.711kg/m</p>	<p>K653</p> <p>壁厚: 1.1mm 重量: 0.377kg/m</p>	<p>K1327</p> <p>壁厚: 1.2mm 重量: 0.348kg/m</p>	<p>K1346</p> <p>壁厚: 1.2mm 重量: 0.427kg/m</p>	<p>K1347</p> <p>壁厚: 1.1mm 重量: 0.569kg/m</p>	<p>K1372</p> <p>壁厚: 2.0mm 重量: 0.468kg/m</p>

<p>K1381</p>  <p>壁厚: 1.5mm 米重: 0.314kg/m</p>	<p>K1384</p>  <p>壁厚: 2.0mm 米重: 0.520kg/m</p>	<p>K1420</p>  <p>壁厚: 2.6mm 米重: 0.753kg/m</p>	<p>K1445</p>  <p>壁厚: 1.5mm 米重: 0.467kg/m</p>	<p>K1721</p>  <p>壁厚: 1.6mm 米重: 0.449kg/m</p>	<p>K1722</p>  <p>壁厚: 1.6mm 米重: 0.420kg/m</p>	<p>K1723</p>  <p>壁厚: 2.0mm 米重: 0.173kg/m</p>	<p>K1724</p>  <p>壁厚: 2.0mm 米重: 0.160kg/m</p>
<p>A492-N</p>  <p>壁厚: 1.5mm 米重: 0.404kg/m</p>	<p>K1039S</p>  <p>壁厚: 1.4mm 米重: 0.451kg/m</p>	<p>K1040S</p>  <p>壁厚: 1.0mm 米重: 0.348kg/m</p>	<p>MY0264</p>  <p>壁厚: 2.0mm 米重: 0.368kg/m</p>	<p>K1709</p>  <p>壁厚: 2.0mm 米重: 0.251kg/m</p>	<p>K1710</p>  <p>壁厚: 1.6mm 米重: 0.378kg/m</p>	<p>K1709A</p>  <p>壁厚: 1.7mm 米重: 0.240kg/m</p>	<p>K1710A</p>  <p>壁厚: 1.7mm 米重: 0.375kg/m</p>
<p>K1039T</p>  <p>壁厚: 1.4mm 米重: 0.457kg/m</p>	<p>K1040T</p>  <p>壁厚: 1.0mm 米重: 0.350kg/m</p>	<p>K2034</p>  <p>壁厚: 2.0mm 米重: 0.529kg/m</p>	<p>K1586</p>  <p>壁厚: 1.5mm 米重: 0.315kg/m</p>	<p>K1711A</p>  <p>壁厚: 1.7mm 米重: 0.529kg/m</p>	<p>K1749</p>  <p>壁厚: 1.2mm 米重: 0.395kg/m</p>	<p>K1763</p>  <p>壁厚: 2.0mm 米重: 0.414kg/m</p>	<p>K1764</p>  <p>壁厚: 2.0mm 米重: 0.554kg/m</p>
<p>K1587</p>  <p>壁厚: 1.5mm 米重: 0.207kg/m</p>	<p>A30-38</p>  <p>壁厚: 2.5mm 米重: 0.374kg/m</p>	<p>A131</p>  <p>壁厚: 2.9mm 米重: 0.342kg/m</p>	<p>MY1569</p>  <p>壁厚: 2.9mm 米重: 0.506kg/m</p>	<p>K1771</p>  <p>壁厚: 1.2mm 米重: 0.338kg/m</p>	<p>K1775</p>  <p>壁厚: 1.2mm 米重: 0.186kg/m</p>	<p>K1776</p>  <p>壁厚: 1.9mm 米重: 0.302kg/m</p>	<p>MY0265</p>  <p>壁厚: 2.5mm 米重: 0.261kg/m</p>
<p>MY1436</p>  <p>壁厚: 1.5mm 米重: 0.522kg/m</p>	<p>K1437</p>  <p>壁厚: 1.5mm 米重: 0.186kg/m</p>	<p>MY1438</p>  <p>壁厚: 1.5mm 米重: 0.304kg/m</p>	<p>K1630</p>  <p>壁厚: 1.5mm 米重: 0.300kg/m</p>	<p>MY0266</p>  <p>壁厚: 2.1mm 米重: 0.422kg/m</p>	<p>K1845</p>  <p>壁厚: 1.25mm 米重: 0.351kg/m</p>	<p>K2002</p>  <p>壁厚: 1.2mm 米重: 0.564kg/m</p>	<p>K2016</p>  <p>壁厚: 1.0mm 米重: 0.288kg/m</p>
<p>A1305</p>  <p>壁厚: 1.0mm 米重: 0.226kg/m</p>	<p>K1649</p>  <p>壁厚: 2.0mm 米重: 0.405kg/m</p>	<p>K1650</p>  <p>壁厚: 2.0mm 米重: 0.318kg/m</p>	<p>K1651</p>  <p>壁厚: 1.7mm 米重: 0.293kg/m</p>	<p>K2017</p>  <p>壁厚: 1.3mm 米重: 0.183kg/m</p>	<p>K2018</p>  <p>壁厚: 1.8mm 米重: 0.415kg/m</p>	<p>K2019</p>  <p>壁厚: 1.8mm 米重: 0.274kg/m</p>	<p>K2020</p>  <p>壁厚: 1.4mm 米重: 0.420kg/m</p>
<p>K1652</p>  <p>壁厚: 1.7mm 米重: 0.334kg/m</p>	<p>K1668</p>  <p>壁厚: 1.0mm 米重: 0.428kg/m</p>	<p>K1669</p>  <p>壁厚: 2.1mm 米重: 0.243kg/m</p>	<p>K1684</p>  <p>壁厚: 1.5mm 米重: 0.393kg/m</p>	<p>K2021</p>  <p>壁厚: 1.0mm 米重: 0.284kg/m</p>	<p>K2022</p>  <p>壁厚: 1.0mm 米重: 0.338kg/m</p>	<p>K2023</p>  <p>壁厚: 1.9mm 米重: 0.627kg/m</p>	<p>K2025</p>  <p>壁厚: 1.4mm 米重: 0.410kg/m</p>









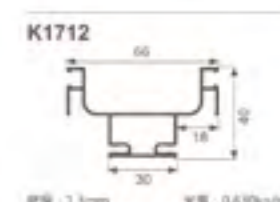
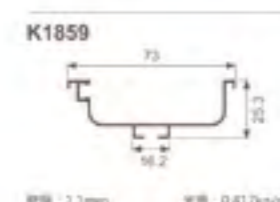
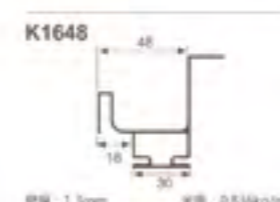
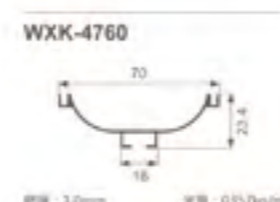
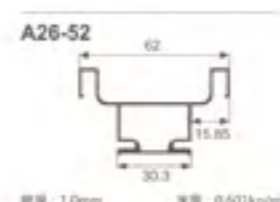
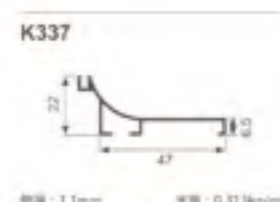
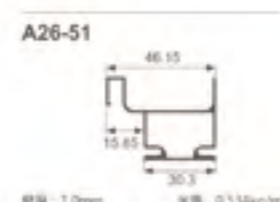
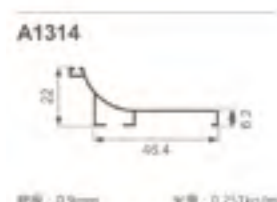
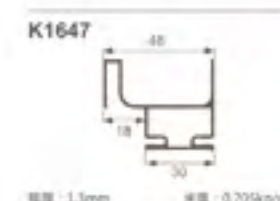
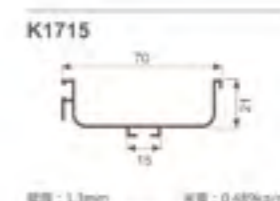
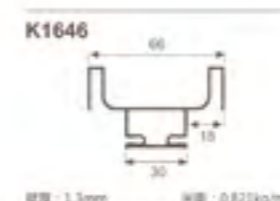
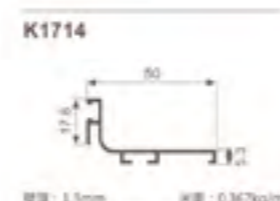
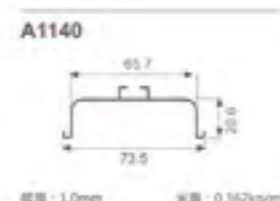
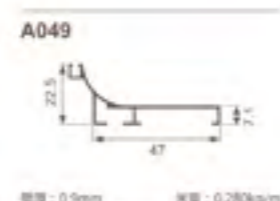
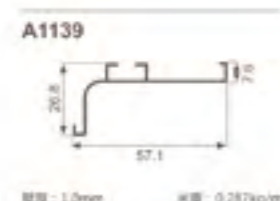
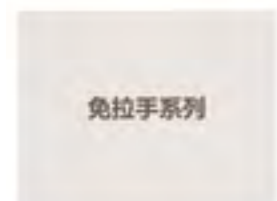
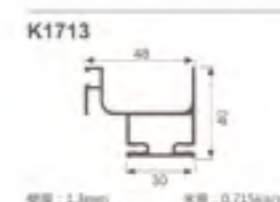
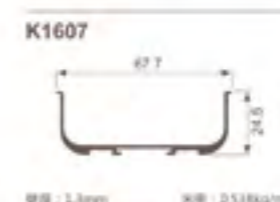
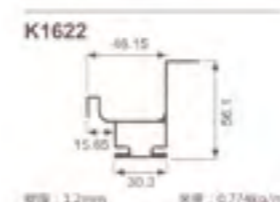
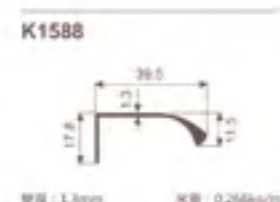
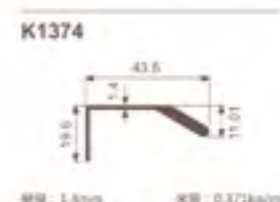
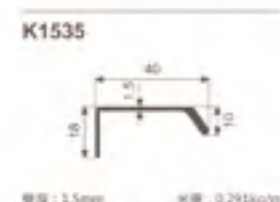
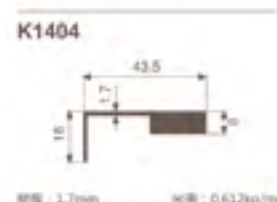
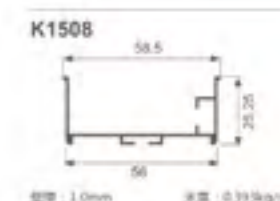
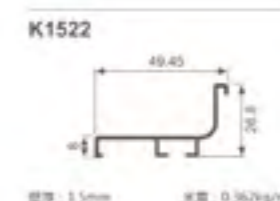
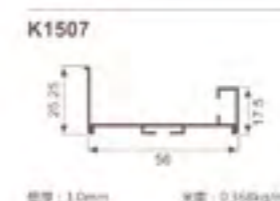
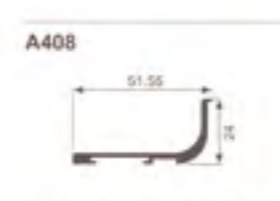
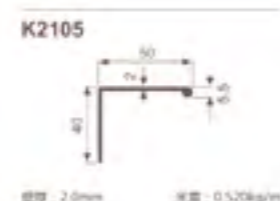
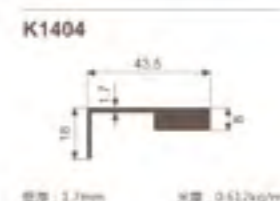
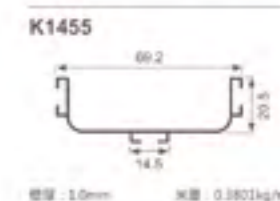
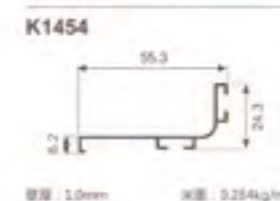
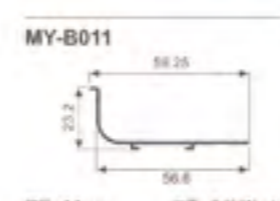
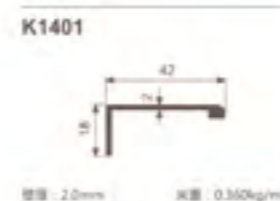
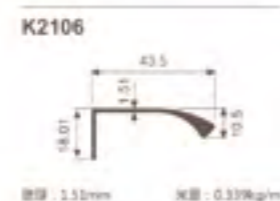
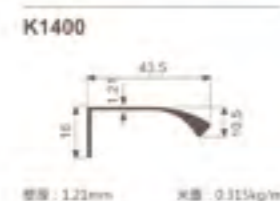
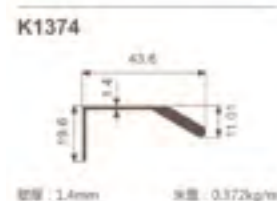
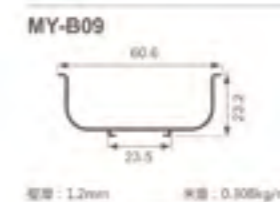
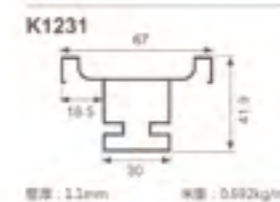
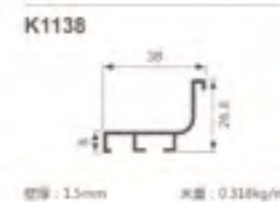
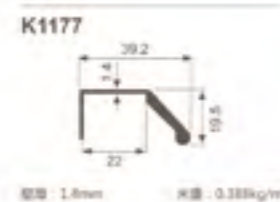
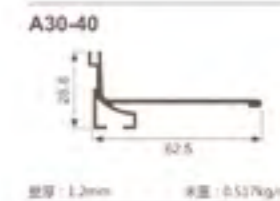
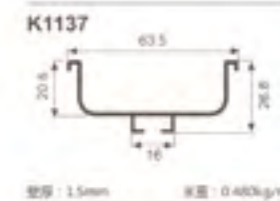
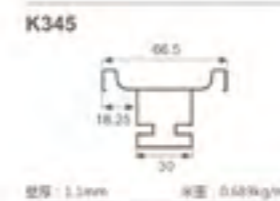
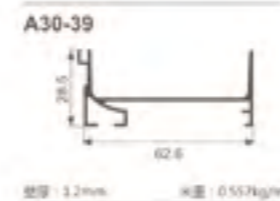

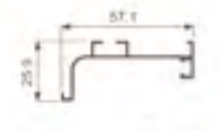
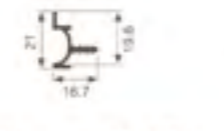

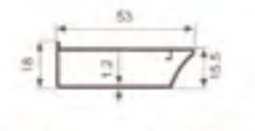
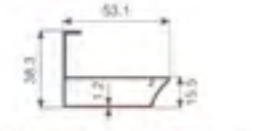
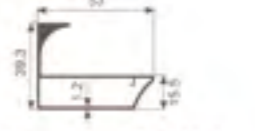
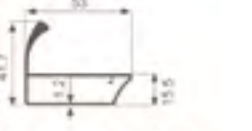

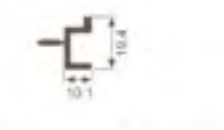

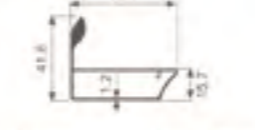
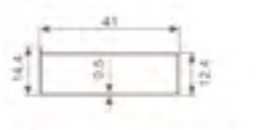
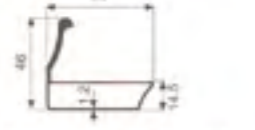
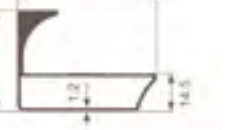

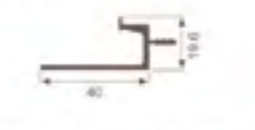

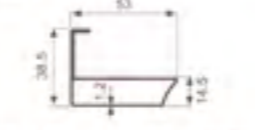
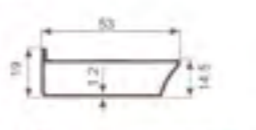
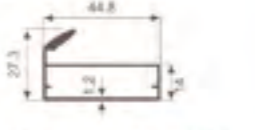
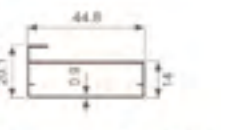
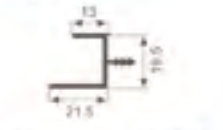
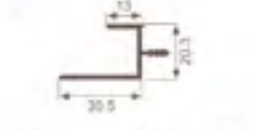
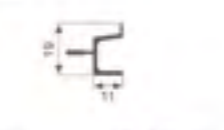
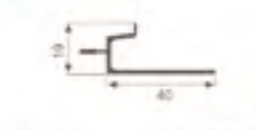

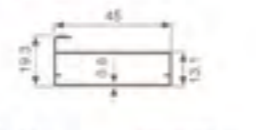
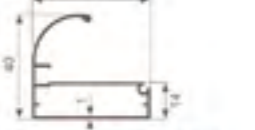
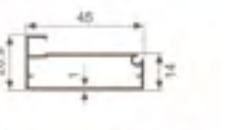

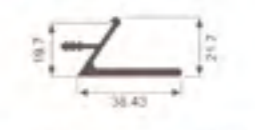
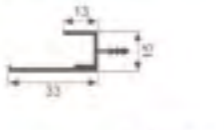

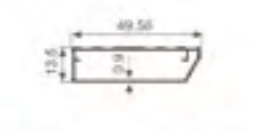
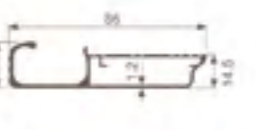
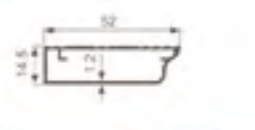
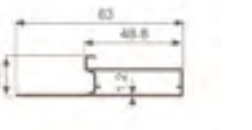
<p>K2026</p> <p>壁厚: 1.4mm 米重: 0.444kg/m</p>	<p>K2027</p> <p>壁厚: 1.4mm 米重: 0.443kg/m</p>	<p>K2028</p> <p>壁厚: 1.0mm 米重: 0.326kg/m</p>	<p>K2029</p> <p>壁厚: 1.8mm 米重: 0.382kg/m</p>	<p>K965</p> <p>壁厚: 8.8mm 米重: 0.371kg/m</p>	<p>K1126</p> <p>壁厚: 1.4mm 米重: 0.100kg/m</p>	<p>K779</p> <p>壁厚: 1.0mm 米重: 0.080kg/m</p>	<p>K1125</p> <p>壁厚: 0.7mm 米重: 0.047kg/m</p>
<p>K2030</p> <p>壁厚: 1.4mm 米重: 0.310kg/m</p>	<p>K2034</p> <p>壁厚: 2.0mm 米重: 0.525kg/m</p>	<p>K2036</p> <p>壁厚: 2.5mm 米重: 0.491kg/m</p>	<p>K2037</p> <p>壁厚: 1.9mm 米重: 0.222kg/m</p>	<p>K1127</p> <p>壁厚: 1.2mm 米重: 0.127kg/m</p>	<p>K1128</p> <p>壁厚: 2.0mm 米重: 0.229kg/m</p>	<p>K1146</p> <p>壁厚: 0.6mm 米重: 0.040kg/m</p>	<p>K1200</p> <p>壁厚: 1.7mm 米重: 0.046kg/m</p>
<p>K2038</p> <p>壁厚: 1.9mm 米重: 0.384kg/m</p>	<p>K2039</p> <p>壁厚: 2.0mm 米重: 0.389kg/m</p>	<p>K2043</p> <p>壁厚: 1.7mm 米重: 0.446kg/m</p>	<p>HK2135</p> <p>壁厚: 1.25mm 米重: 0.417kg/m</p>	<p>K1201</p> <p>壁厚: 1.7mm 米重: 0.072kg/m</p>	<p>K1202</p> <p>壁厚: 1.7mm 米重: 0.094kg/m</p>	<p>K1203</p> <p>壁厚: 6.0mm 米重: 0.194kg/m</p>	<p>K1322</p> <p>壁厚: 1.5mm 米重: 0.098kg/m</p>
<p>K2147</p> <p>壁厚: 2.0mm 米重: 0.392kg/m</p>	<p>A30-38</p> <p>壁厚: 2.5mm 米重: 0.374kg/m</p>	<p>A1305N</p> <p>壁厚: 1.0mm 米重: 0.227kg/m</p>	<p>K1039T</p> <p>壁厚: 1.4mm 米重: 0.457kg/m</p>	<p>K1392</p> <p>壁厚: 0.6mm 米重: 0.027kg/m</p>	<p>K1393</p> <p>壁厚: 0.6mm 米重: 0.034kg/m</p>	<p>K1394</p> <p>壁厚: 0.6mm 米重: 0.026kg/m</p>	<p>K1398</p> <p>壁厚: 4.2mm 米重: 0.139kg/m</p>
<p>K1830</p> <p>壁厚: 1.0mm 米重: 0.586kg/m</p>	<p>K1831</p> <p>壁厚: 1.0mm 米重: 0.239kg/m</p>	<p>K1832</p> <p>壁厚: 1.6mm 米重: 0.254kg/m</p>	<p>K1833</p> <p>壁厚: 1.6mm 米重: 0.178kg/m</p>	<p>K1549</p> <p>壁厚: 1.6mm 米重: 0.051kg/m</p>	<p>K1655</p> <p>壁厚: 2.0mm 米重: 0.037kg/m</p>	<p>K1751</p> <p>壁厚: 1.8mm 米重: 0.112kg/m</p>	<p>K2044</p> <p>壁厚: 1.0mm 米重: 0.015kg/m</p>
<p>丁字条系列</p>	<p>K397</p> <p>壁厚: 1.0mm 米重: 0.084kg/m</p>	<p>K518</p> <p>壁厚: 1.0mm 米重: 0.079kg/m</p>	<p>K713</p> <p>壁厚: 2.65mm 米重: 0.061kg/m</p>	<p>K2043</p> <p>壁厚: 1.0mm 米重: 0.043kg/m</p>	<p>K1757</p> <p>壁厚: 1.7mm 米重: 0.086kg/m</p>	<p>K1695</p> <p>壁厚: 12mm 米重: 0.180kg/m</p>	<p>K1850</p> <p>壁厚: 0.6mm 米重: 0.062kg/m</p>
<p>K723</p> <p>壁厚: 5.0mm 米重: 0.494kg/m</p>	<p>K741</p> <p>壁厚: 3.0mm 米重: 0.241kg/m</p>	<p>K752</p> <p>壁厚: 2.5mm 米重: 0.201kg/m</p>	<p>K778</p> <p>壁厚: 0.95mm 米重: 0.046kg/m</p>	<p>K2126</p> <p>壁厚: 0.8mm 米重: 0.112kg/m</p>	<p>K264</p> <p>壁厚: 0.9mm 米重: 0.092kg/m</p>	<p>K265</p> <p>壁厚: 0.8mm 米重: 0.082kg/m</p>	<p>K400</p> <p>壁厚: 0.7mm 米重: 0.073kg/m</p>

<p>K623</p> <p>壁厚: 1.0mm 米重: 0.131kg/m</p>	<p>K101</p> <p>壁厚: 1.6mm 米重: 0.090kg/m</p>	<p>K1332</p> <p>壁厚: 1.6mm 米重: 0.122kg/m</p>	<p>K1691</p> <p>壁厚: 1.7mm 米重: 0.103kg/m</p>	<p>K113</p> <p>壁厚: 2.2mm 米重: 0.310kg/m</p>	<p>K114</p> <p>壁厚: 1.5mm 米重: 0.275kg/m</p>	<p>K115</p> <p>壁厚: 1.5mm 米重: 0.357kg/m</p>	<p>K116</p> <p>壁厚: 1.6mm 米重: 0.297kg/m</p>
<p>K263</p> <p>壁厚: 1.7mm 米重: 0.122kg/m</p>	<p>K262</p> <p>壁厚: 1.6mm 米重: 0.121kg/m</p>	<p>K398</p> <p>壁厚: 0.9mm 米重: 0.094kg/m</p>	<p>K267</p> <p>壁厚: 2.0mm 米重: 0.143kg/m</p>	<p>K201</p> <p>壁厚: 2.2mm 米重: 0.319kg/m</p>	<p>K202</p> <p>壁厚: 5.0mm 米重: 0.509kg/m</p>	<p>K203</p> <p>壁厚: 2.7mm 米重: 0.443kg/m</p>	<p>K224</p> <p>壁厚: 2.5mm 米重: 0.375kg/m</p>
<p>K425</p> <p>壁厚: 0.9mm 米重: 0.103kg/m</p>	<p>K435</p> <p>壁厚: 0.75mm 米重: 0.084kg/m</p>	<p>K423</p> <p>壁厚: 1.6mm 米重: 0.151kg/m</p>	<p>K428</p> <p>壁厚: 0.9mm 米重: 0.100kg/m</p>	<p>K225</p> <p>壁厚: 2.2mm 米重: 0.314kg/m</p>	<p>K247</p> <p>壁厚: 2.6mm 米重: 0.441kg/m</p>	<p>K254</p> <p>壁厚: 2.9mm 米重: 0.484kg/m</p>	<p>K266</p> <p>壁厚: 3.0mm 米重: 0.417kg/m</p>
<p>K440</p> <p>壁厚: 1.2mm 米重: 0.129kg/m</p>	<p>K654</p> <p>壁厚: 1.1mm 米重: 0.073kg/m</p>	<p>K712</p> <p>壁厚: 1.0mm 米重: 0.085kg/m</p>	<p>K715</p> <p>壁厚: 1.1mm 米重: 0.070kg/m</p>	<p>K1242</p> <p>壁厚: 1.2mm 米重: 0.175kg/m</p>	<p>K290</p> <p>壁厚: 2.9mm 米重: 0.426kg/m</p>	<p>K307</p> <p>壁厚: 3.0mm 米重: 0.384kg/m</p>	<p>K311</p> <p>壁厚: 2.5mm 米重: 0.480kg/m</p>
<p>K943</p> <p>壁厚: 1.0mm 米重: 0.108kg/m</p>	<p>K1059</p> <p>壁厚: 0.7mm 米重: 0.071kg/m</p>	<p>K1471</p> <p>壁厚: 1.2mm 米重: 0.138kg/m</p>	<p>K1509</p> <p>壁厚: 0.95mm 米重: 0.083kg/m</p>	<p>K318</p> <p>壁厚: 3.0mm 米重: 0.510kg/m</p>	<p>K321</p> <p>壁厚: 2.0mm 米重: 0.343kg/m</p>	<p>K1280</p> <p>壁厚: 3.0mm 米重: 0.454kg/m</p>	<p>K373</p> <p>壁厚: 2.3mm 米重: 0.437kg/m</p>
<p>K510</p> <p>壁厚: 0.75mm 米重: 0.089kg/m</p>	<p>K1605</p> <p>壁厚: 2.0mm 米重: 0.136kg/m</p>	<p>K1692</p> <p>壁厚: 1.2mm 米重: 0.128kg/m</p>	<p>K1693</p> <p>壁厚: 1.2mm 米重: 0.138kg/m</p>	<p>K374</p> <p>壁厚: 2.6mm 米重: 0.552kg/m</p>	<p>K413</p> <p>壁厚: 2.5mm 米重: 0.362kg/m</p>	<p>K517</p> <p>壁厚: 2.2mm 米重: 0.380kg/m</p>	<p>K521</p> <p>壁厚: 3.0mm 米重: 0.375kg/m</p>
<p>K1694</p> <p>壁厚: 1.2mm 米重: 0.157kg/m</p>	<p>K508</p> <p>壁厚: 3.0mm 米重: 0.454kg/m</p>	<p>K1123</p> <p>壁厚: 2.0mm 米重: 0.372kg/m</p>	<p>K620</p> <p>壁厚: 2.5mm 米重: 0.494kg/m</p>	<p>K637</p> <p>壁厚: 3.0mm 米重: 0.430kg/m</p>			

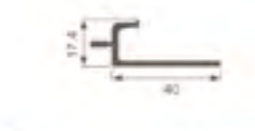
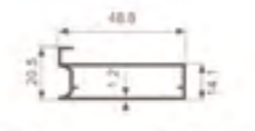
<p>K645</p> <p>壁厚: 2.6mm 米重: 0.488kg/m</p>	<p>K1164</p> <p>壁厚: 2.6mm 米重: 0.379kg/m</p>	<p>K680</p> <p>壁厚: 2.0mm 米重: 0.264kg/m</p>	<p>K683</p> <p>壁厚: 3.1mm 米重: 0.501kg/m</p>	<p>K1402</p> <p>壁厚: 1.8mm 米重: 0.117kg/m</p>	<p>K1614</p> <p>壁厚: 2.0mm 米重: 0.170kg/m</p>	<p>K1435</p> <p>壁厚: 1.8mm 米重: 0.359kg/m</p>	<p>K1659</p> <p>壁厚: 3.0mm 米重: 0.408kg/m</p>
<p>K693</p> <p>壁厚: 2.5mm 米重: 0.301kg/m</p>	<p>K694</p> <p>壁厚: 3.0mm 米重: 0.348kg/m</p>	<p>K709</p> <p>壁厚: 2.5mm 米重: 0.199kg/m</p>	<p>K718</p> <p>壁厚: 2.0mm 米重: 0.433kg/m</p>	<p>K1460</p> <p>壁厚: 1.0mm 米重: 0.634kg/m</p>	<p>K521</p> <p>壁厚: 3.0mm 米重: 0.357kg/m</p>	<p>K1512</p> <p>壁厚: 3.0mm 米重: 0.428kg/m</p>	<p>K1660</p> <p>壁厚: 3.0mm 米重: 0.322kg/m</p>
<p>K720</p> <p>壁厚: 3.0mm 米重: 0.394kg/m</p>	<p>K721</p> <p>壁厚: 3.0mm 米重: 0.379kg/m</p>	<p>K722</p> <p>壁厚: 5.0mm 米重: 0.811kg/m</p>	<p>K724</p> <p>壁厚: 2.5mm 米重: 0.411kg/m</p>	<p>K1614</p> <p>壁厚: 2.4mm 米重: 0.413kg/m</p>	<p>K222A</p> <p>壁厚: 1.8mm 米重: 0.242kg/m</p>	<p>K201</p> <p>壁厚: 2.2mm 米重: 0.329kg/m</p>	<p>K1402</p> <p>壁厚: 1.8mm 米重: 0.117kg/m</p>
<p>K748</p> <p>壁厚: 3.0mm 米重: 0.448kg/m</p>	<p>K759</p> <p>壁厚: 2.6mm 米重: 0.358kg/m</p>	<p>K760</p> <p>壁厚: 3.0mm 米重: 0.517kg/m</p>	<p>K769</p> <p>壁厚: 1.3mm 米重: 0.348kg/m</p>	<p>K2000</p> <p>壁厚: 2.7mm 米重: 0.471kg/m</p>	<p>K2001</p> <p>壁厚: 3.0mm 米重: 0.348kg/m</p>	<p>K2007</p> <p>壁厚: 2.2mm 米重: 0.377kg/m</p>	<p>K2107</p> <p>壁厚: 2.01mm 米重: 0.360kg/m</p>
<p>K976</p> <p>壁厚: 1.8mm 米重: 0.238kg/m</p>	<p>K1008</p> <p>壁厚: 3.0mm 米重: 0.433kg/m</p>	<p>K1060</p> <p>壁厚: 3.0mm 米重: 0.402kg/m</p>	<p>K1239</p> <p>壁厚: 3.0mm 米重: 0.441kg/m</p>	<p>K2108</p> <p>壁厚: 2.0mm 米重: 0.401kg/m</p>	<p>K2109</p> <p>壁厚: 2.0mm 米重: 0.369kg/m</p>	<p>K2110</p> <p>壁厚: 2.0mm 米重: 0.306kg/m</p>	<p>K1323</p> <p>壁厚: 1.8mm 米重: 0.355kg/m</p>
<p>K1281</p> <p>壁厚: 3.0mm 米重: 0.442kg/m</p>	<p>K1282</p> <p>壁厚: 3.0mm 米重: 0.524kg/m</p>	<p>K1323</p> <p>壁厚: 1.8mm 米重: 0.355kg/m</p>	<p>K1324</p> <p>壁厚: 1.7mm 米重: 0.354kg/m</p>	<p>K1260</p> <p>壁厚: 1.5mm 米重: 0.276kg/m</p>	<p>K1324</p> <p>壁厚: 1.7mm 米重: 0.474kg/m</p>	<p>K1123</p> <p>壁厚: 2.2mm 米重: 0.372kg/m</p>	<p>K1435</p> <p>壁厚: 1.8mm 米重: 0.359kg/m</p>
<p>K1335</p> <p>壁厚: 1.8mm 米重: 0.359kg/m</p>	<p>K580</p> <p>壁厚: 5.0mm 米重: 0.454kg/m</p>	<p>K1459</p> <p>壁厚: 3.0mm 米重: 0.511kg/m</p>	<p>K266</p> <p>壁厚: 3.0mm 米重: 0.417kg/m</p>	<p>K102</p> <p>壁厚: 1.8mm 米重: 0.426kg/m</p>	<p>K104</p> <p>壁厚: 1.3mm 米重: 0.345kg/m</p>	<p>K103</p> <p>壁厚: 1.9mm 米重: 0.452kg/m</p>	<p>K105</p> <p>壁厚: 1.9mm 米重: 0.528kg/m</p>

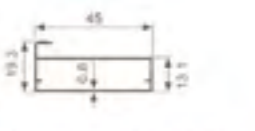
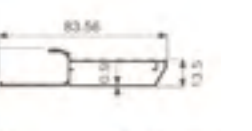
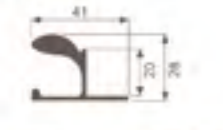
<p>K106</p> <p>壁厚: 1.9mm 米重: 0.287kg/m</p>	<p>K112</p> <p>壁厚: 1.9mm 米重: 0.374kg/m</p>	<p>K131</p> <p>壁厚: 3.15mm 米重: 0.119kg/m</p>	<p>K1119</p> <p>壁厚: 1.8mm 米重: 0.374kg/m</p>	<p>K1623</p> <p>壁厚: 1.8mm 米重: 0.423kg/m</p>	<p>K2003</p> <p>壁厚: 1.8mm 米重: 0.361kg/m</p>	<p>K2004</p> <p>壁厚: 1.8mm 米重: 0.426kg/m</p>	<p>K2005</p> <p>壁厚: 1.8mm 米重: 0.416kg/m</p>
<p>K332</p> <p>壁厚: 2.0mm 米重: 0.558kg/m</p>	<p>K333</p> <p>壁厚: 2.0mm 米重: 0.567kg/m</p>	<p>K334</p> <p>壁厚: 2.0mm 米重: 0.511kg/m</p>	<p>K356</p> <p>壁厚: 2.8mm 米重: 0.591kg/m</p>	<p>K2006</p> <p>壁厚: 1.8mm 米重: 0.345kg/m</p>	<p>K2010</p> <p>壁厚: 1.5mm 米重: 0.407kg/m</p>	<p>K2011</p> <p>壁厚: 1.8mm 米重: 0.554kg/m</p>	<p>K2012</p> <p>壁厚: 1.8mm 米重: 0.520kg/m</p>
<p>K1559</p> <p>壁厚: 2.5mm 米重: 0.510kg/m</p>	<p>K1560</p> <p>壁厚: 2.5mm 米重: 0.242kg/m</p>	<p>K2009</p> <p>壁厚: 2.0mm 米重: 0.334kg/m</p>	<p>K2008</p> <p>壁厚: 0.7mm 米重: 0.059kg/m</p>	<p>K2040</p> <p>壁厚: 2.0mm 米重: 0.478kg/m</p>	<p>K2015</p> <p>壁厚: 1.6mm 米重: 0.304kg/m</p>	<p>K2013</p> <p>壁厚: 1.8mm 米重: 0.531kg/m</p>	<p>K2014</p> <p>壁厚: 1.8mm 米重: 0.576kg/m</p>
<p>K726</p> <p>壁厚: 1.8mm 米重: 0.312kg/m</p>	<p>K725</p> <p>壁厚: 1.8mm 米重: 0.129kg/m</p>	<p>K533</p> <p>壁厚: 2.0mm 米重: 0.251kg/m</p>	<p>K537</p> <p>壁厚: 2.0mm 米重: 0.129kg/m</p>	<p>K1419</p> <p>壁厚: 1.8mm 米重: 0.324kg/m</p>	<p>K283</p> <p>壁厚: 1.5mm 米重: 0.268kg/m</p>	<p>K1043</p> <p>壁厚: 1.0mm 米重: 0.568kg/m</p>	<p>K355</p> <p>壁厚: 1.5mm 米重: 0.481kg/m</p>
<p>K1014</p> <p>壁厚: 1.2mm 米重: 0.362kg/m</p>	<p>K399</p> <p>壁厚: 1.2mm 米重: 0.182kg/m</p>	<p>K1546</p> <p>壁厚: 2.4mm 米重: 0.447kg/m</p>	<p>K1545</p> <p>壁厚: 2.4mm 米重: 0.119kg/m</p>	<p>K1044</p> <p>壁厚: 1.0mm 米重: 0.728kg/m</p>	<p>K583</p> <p>壁厚: 1.0mm 米重: 0.188kg/m</p>	<p>K1045</p> <p>壁厚: 1.0mm 米重: 0.578kg/m</p>	<p>K657</p> <p>壁厚: 1.3mm 米重: 0.276kg/m</p>
<p>K1561</p> <p>壁厚: 2.5mm 米重: 0.490kg/m</p>	<p>K1562</p> <p>壁厚: 2.5mm 米重: 0.221kg/m</p>	<p>K2060</p> <p>壁厚: 2.4mm 米重: 0.548kg/m</p>	<p>K2061</p> <p>壁厚: 2.4mm 米重: 0.348kg/m</p>	<p>K1061</p> <p>壁厚: 1.5mm 米重: 0.269kg/m</p>	<p>K1031</p> <p>壁厚: 2.0mm 米重: 0.451kg/m</p>	<p>K1062</p> <p>壁厚: 1.5mm 米重: 0.308kg/m</p>	<p>K1042</p> <p>壁厚: 3.0mm 米重: 0.522kg/m</p>
<p>K2009</p> <p>壁厚: 2.0mm 米重: 0.335kg/m</p>	<p>K947</p> <p>壁厚: 1.8mm 米重: 0.102kg/m</p>	<p>K1323</p> <p>壁厚: 1.8mm 米重: 0.355kg/m</p>	<p>K1742</p> <p>壁厚: 1.5mm 米重: 0.232kg/m</p>	<p>K1063</p> <p>壁厚: 1.2mm 米重: 0.237kg/m</p>	<p>K1106</p> <p>壁厚: 1.5mm 米重: 0.411kg/m</p>	<p>K1226</p> <p>壁厚: 2.0mm 米重: 0.352kg/m</p>	<p>K1110</p> <p>壁厚: 1.5mm 米重: 0.342kg/m</p>

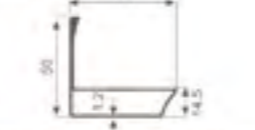

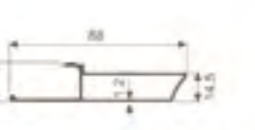
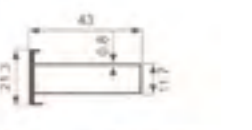
<p>K1860</p>  <p>壁厚: 1.1mm 米重: 0.376kg/m</p>	<p>字母拉手系列</p>	<p>K1775</p>  <p>壁厚: 1.9mm 米重: 0.386kg/m</p>	<p>K1776</p>  <p>壁厚: 1.9mm 米重: 0.302kg/m</p>	<p>K107</p>  <p>壁厚: 1.2mm 米重: 0.433kg/m</p>	<p>K108</p>  <p>壁厚: 1.2mm 米重: 0.564kg/m</p>	<p>K109</p>  <p>壁厚: 1.2mm 米重: 0.694kg/m</p>	<p>K110</p>  <p>壁厚: 1.2mm 米重: 0.651kg/m</p>	
<p>K1668</p>  <p>壁厚: 2.1mm 米重: 0.428kg/m</p>		<p>K1669</p>  <p>壁厚: 2.1mm 米重: 0.244kg/m</p>	<p>MY0265</p>  <p>壁厚: 2.1mm 米重: 0.265kg/m</p>	<p>MY0266</p>  <p>壁厚: 2.5mm 米重: 0.428kg/m</p>	<p>K111</p>  <p>壁厚: 1.2mm 米重: 0.668kg/m</p>	<p>K136</p>  <p>壁厚: 0.5mm 米重: 0.145kg/m</p>	<p>K207</p>  <p>壁厚: 1.2mm 米重: 0.681kg/m</p>	<p>K208</p>  <p>壁厚: 1.2mm 米重: 0.742kg/m</p>
<p>K1709</p>  <p>壁厚: 2.0mm 米重: 0.231kg/m</p>		<p>K1710</p>  <p>壁厚: 2.0mm 米重: 0.379kg/m</p>	<p>K1709A</p>  <p>壁厚: 1.7mm 米重: 0.240kg/m</p>	<p>K1710A</p>  <p>壁厚: 1.7mm 米重: 0.373kg/m</p>	<p>K209</p>  <p>壁厚: 1.2mm 米重: 0.573kg/m</p>	<p>K210</p>  <p>壁厚: 1.2mm 米重: 0.417kg/m</p>	<p>K229</p>  <p>壁厚: 1.0mm 米重: 0.416kg/m</p>	<p>K230</p>  <p>壁厚: 0.8mm 米重: 0.302kg/m</p>
<p>K1651</p>  <p>壁厚: 1.7mm 米重: 0.292kg/m</p>		<p>K1652</p>  <p>壁厚: 1.7mm 米重: 0.334kg/m</p>	<p>MY1437</p>  <p>壁厚: 1.5mm 米重: 0.186kg/m</p>	<p>MY1438</p>  <p>壁厚: 1.5mm 米重: 0.304kg/m</p>	<p>K231</p>  <p>壁厚: 0.8mm 米重: 0.134kg/m</p>	<p>K232</p>  <p>壁厚: 0.8mm 米重: 0.282kg/m</p>	<p>K233</p>  <p>壁厚: 1.0mm 米重: 0.482kg/m</p>	<p>K234</p>  <p>壁厚: 1.0mm 米重: 0.371kg/m</p>
<p>A131</p>  <p>壁厚: 2.0mm 米重: 0.342kg/m</p>		<p>MY1569</p>  <p>壁厚: 1.8mm 米重: 0.500kg/m</p>	<p>K1586</p>  <p>壁厚: 1.5mm 米重: 0.315kg/m</p>	<p>K1587</p>  <p>壁厚: 1.5mm 米重: 0.207kg/m</p>	<p>K235</p>  <p>壁厚: 0.8mm 米重: 0.173kg/m</p>	<p>K236</p>  <p>壁厚: 1.2mm 米重: 0.748kg/m</p>	<p>K237</p>  <p>壁厚: 1.2mm 米重: 0.427kg/m</p>	<p>K256</p>  <p>壁厚: 1.2mm 米重: 0.576kg/m</p>
<p>K2018</p>  <p>壁厚: 1.8mm 米重: 0.273kg/m</p>		<p>K2019</p>  <p>壁厚: 1.8mm 米重: 0.413kg/m</p>	<p>K2037</p>  <p>壁厚: 1.9mm 米重: 0.222kg/m</p>	<p>K2038</p>  <p>壁厚: 1.8mm 米重: 0.383kg/m</p>	<p>K257</p>  <p>壁厚: 1.2mm 米重: 0.453kg/m</p>	<p>K258</p>  <p>壁厚: 0.8mm 米重: 0.334kg/m</p>	<p>K259</p>  <p>壁厚: 0.8mm 米重: 0.282kg/m</p>	<p>K260</p>  <p>壁厚: 0.9mm 米重: 0.563kg/m</p>
<p>K1046</p>  <p>壁厚: 2.0mm 米重: 0.745kg/m</p>		<p>K1047</p>  <p>壁厚: 1.8mm 米重: 0.886kg/m</p>			<p>K292</p>  <p>壁厚: 1.2mm 米重: 0.637kg/m</p>	<p>K293</p>  <p>壁厚: 1.2mm 米重: 0.713kg/m</p>	<p>K294</p>  <p>壁厚: 1.2mm 米重: 0.620kg/m</p>	<p>K304</p>  <p>壁厚: 0.8mm 米重: 0.331kg/m</p>

<p>K305</p> <p>壁厚: 0.8mm 米重: 0.578kg/m</p>	<p>K306</p> <p>壁厚: 1.0mm 米重: 0.531kg/m</p>	<p>K358</p> <p>壁厚: 0.9mm 米重: 0.268kg/m</p>	<p>K359</p> <p>壁厚: 0.9mm 米重: 0.320kg/m</p>	<p>K453</p> <p>壁厚: 1.1mm 米重: 0.470kg/m</p>	<p>K454</p> <p>壁厚: 1.1mm 米重: 0.490kg/m</p>	<p>K455</p> <p>壁厚: 1.2mm 米重: 0.456kg/m</p>	<p>K456</p> <p>壁厚: 1.0mm 米重: 0.350kg/m</p>
<p>K362</p> <p>壁厚: 1.0mm 米重: 0.394kg/m</p>	<p>K363</p> <p>壁厚: 1.0mm 米重: 0.538kg/m</p>	<p>K364</p> <p>壁厚: 1.0mm 米重: 0.480kg/m</p>	<p>K365</p> <p>壁厚: 1.0mm 米重: 0.528kg/m</p>	<p>K457</p> <p>壁厚: 1.0mm 米重: 0.413kg/m</p>	<p>K458</p> <p>壁厚: 1.1mm 米重: 0.774kg/m</p>	<p>K459</p> <p>壁厚: 1.2mm 米重: 0.390kg/m</p>	<p>K460</p> <p>壁厚: 1.2mm 米重: 0.427kg/m</p>
<p>K370</p> <p>壁厚: 0.6mm 米重: 0.385kg/m</p>	<p>K378A</p> <p>壁厚: 0.7mm 米重: 0.211kg/m</p>	<p>K378</p> <p>壁厚: 0.7mm 米重: 0.211kg/m</p>	<p>K384</p> <p>壁厚: 1.2mm 米重: 0.578kg/m</p>	<p>K461</p> <p>壁厚: 1.2mm 米重: 0.563kg/m</p>	<p>K462</p> <p>壁厚: 0.9mm 米重: 0.377kg/m</p>	<p>K463</p> <p>壁厚: 0.9mm 米重: 0.334kg/m</p>	<p>K464</p> <p>壁厚: 1.0mm 米重: 0.423kg/m</p>
<p>K385</p> <p>壁厚: 0.9mm 米重: 0.513kg/m</p>	<p>K407</p> <p>壁厚: 0.8mm 米重: 0.508kg/m</p>	<p>K408</p> <p>壁厚: 0.8mm 米重: 0.549kg/m</p>	<p>K409</p> <p>壁厚: 0.8mm 米重: 0.432kg/m</p>	<p>K465</p> <p>壁厚: 1.0mm 米重: 0.366kg/m</p>	<p>K466</p> <p>壁厚: 1.5mm 米重: 0.845kg/m</p>	<p>K467</p> <p>壁厚: 1.5mm 米重: 0.623kg/m</p>	<p>K468</p> <p>壁厚: 1.9mm 米重: 1.256kg/m</p>
<p>K410</p> <p>壁厚: 0.8mm 米重: 0.304kg/m</p>	<p>K416</p> <p>壁厚: 1.1mm 米重: 0.412kg/m</p>	<p>K417</p> <p>壁厚: 1.1mm 米重: 0.567kg/m</p>	<p>K418</p> <p>壁厚: 1.1mm 米重: 0.678kg/m</p>	<p>K469</p> <p>壁厚: 1.9mm 米重: 0.623kg/m</p>	<p>K470</p> <p>壁厚: 1.5mm 米重: 0.774kg/m</p>	<p>K472</p> <p>壁厚: 1.5mm 米重: 0.838kg/m</p>	<p>K475</p> <p>壁厚: 1.0mm 米重: 0.636kg/m</p>
<p>K419</p> <p>壁厚: 1.1mm 米重: 0.537kg/m</p>	<p>K446</p> <p>壁厚: 1.2mm 米重: 0.380kg/m</p>	<p>K447</p> <p>壁厚: 1.0mm 米重: 0.340kg/m</p>	<p>K448</p> <p>壁厚: 1.1mm 米重: 0.419kg/m</p>	<p>K478</p> <p>壁厚: 0.8mm 米重: 0.284kg/m</p>	<p>K479</p> <p>壁厚: 0.8mm 米重: 0.488kg/m</p>	<p>K482</p> <p>壁厚: 0.8mm 米重: 0.335kg/m</p>	<p>K483</p> <p>壁厚: 1.0mm 米重: 0.363kg/m</p>
<p>K449</p> <p>壁厚: 1.0mm 米重: 0.314kg/m</p>	<p>K450</p> <p>壁厚: 1.0mm 米重: 0.434kg/m</p>	<p>K451</p> <p>壁厚: 1.1mm 米重: 0.407kg/m</p>	<p>K452</p> <p>壁厚: 1.1mm 米重: 0.552kg/m</p>	<p>K490</p> <p>壁厚: 1.0mm 米重: 0.391kg/m</p>	<p>K492</p> <p>壁厚: 0.9mm 米重: 0.327kg/m</p>	<p>K493</p> <p>壁厚: 0.9mm 米重: 0.594kg/m</p>	<p>K494</p> <p>壁厚: 0.9mm 米重: 0.439kg/m</p>

K495



壁厚: 0.9mm 米重: 0.797kg/m

K496

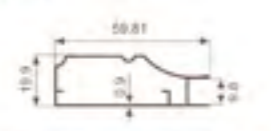

壁厚: 0.9mm 米重: 0.598kg/m

K497



壁厚: 0.9mm 米重: 0.750kg/m

K498

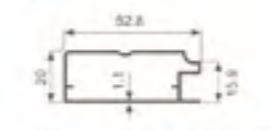

壁厚: 1.1mm 米重: 0.454kg/m

K549

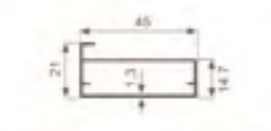

壁厚: 1.1mm 米重: 0.400kg/m

K550

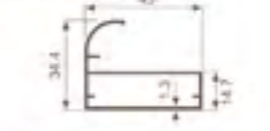

壁厚: 1.1mm 米重: 0.477kg/m

K564

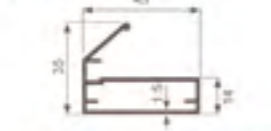

壁厚: 1.5mm 米重: 0.517kg/m

K568

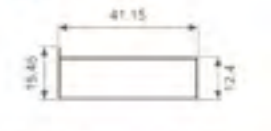

壁厚: 0.55mm 米重: 0.163kg/m

K499

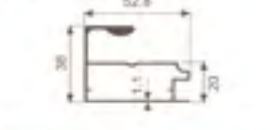

壁厚: 1.1mm 米重: 0.728kg/m

K500

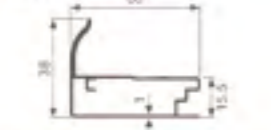

壁厚: 1.0mm 米重: 0.523kg/m

K501

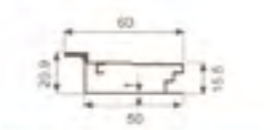

壁厚: 1.0mm 米重: 0.490kg/m

K502

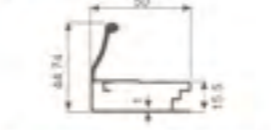

壁厚: 1.0mm 米重: 0.635kg/m

K575

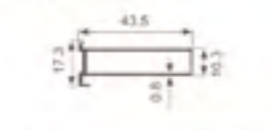

壁厚: 0.6mm 米重: 0.268kg/m

K578

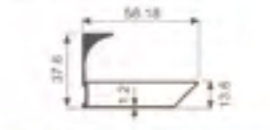

壁厚: 1.2mm 米重: 0.712kg/m

K579

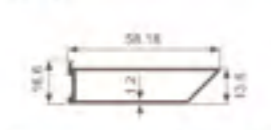

壁厚: 1.2mm 米重: 0.423kg/m

K582

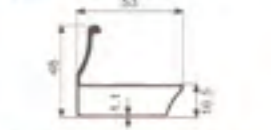

壁厚: 1.1mm 米重: 0.607kg/m

K503



壁厚: 1.0mm 米重: 0.549kg/m

K504

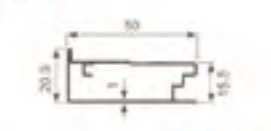

壁厚: 1.0mm 米重: 0.425kg/m

K505

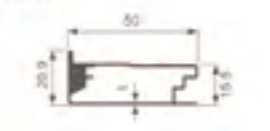

壁厚: 1.0mm 米重: 0.572kg/m

K506

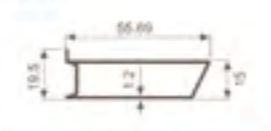

壁厚: 1.2mm 米重: 0.454kg/m

K587



壁厚: 1.6mm 米重: 0.866kg/m

K588

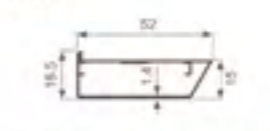

壁厚: 1.4mm 米重: 0.432kg/m

K593

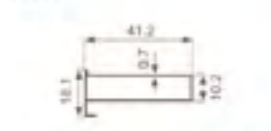

壁厚: 0.7mm 米重: 0.217kg/m

K596

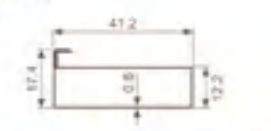

壁厚: 0.6mm 米重: 0.197kg/m

K507

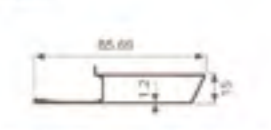

壁厚: 1.2mm 米重: 0.603kg/m

K508

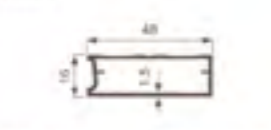

壁厚: 1.5mm 米重: 0.503kg/m

K509

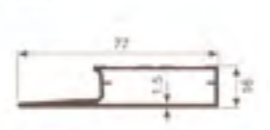

壁厚: 1.5mm 米重: 0.718kg/m

K513

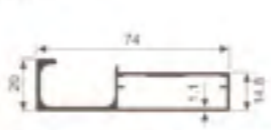

壁厚: 1.1mm 米重: 0.643kg/m

K599

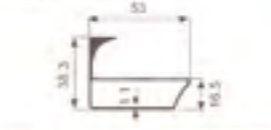

壁厚: 1.1mm 米重: 0.532kg/m

K603

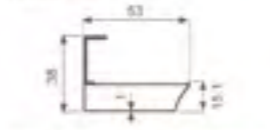

壁厚: 1.0mm 米重: 0.513kg/m

K604

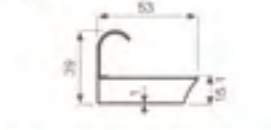

壁厚: 1.0mm 米重: 0.548kg/m

K605

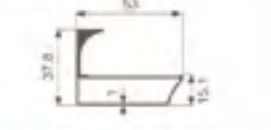

壁厚: 1.0mm 米重: 0.512kg/m

K514

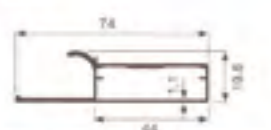

壁厚: 1.1mm 米重: 0.615kg/m

K515

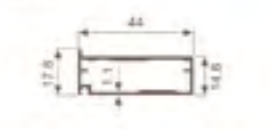

壁厚: 1.1mm 米重: 0.437kg/m

K522



壁厚: 1.0mm 米重: 0.536kg/m

K525

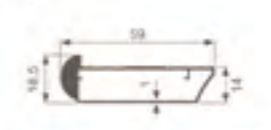

壁厚: 1.0mm 米重: 0.591kg/m

K612

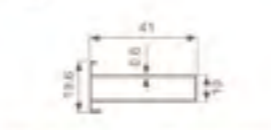

壁厚: 0.6mm 米重: 0.192kg/m

K615

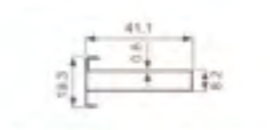

壁厚: 0.6mm 米重: 0.209kg/m

K617

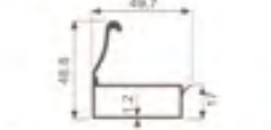

壁厚: 1.2mm 米重: 0.513kg/m

K618

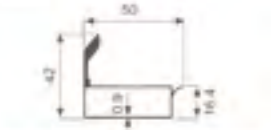

壁厚: 0.9mm 米重: 0.542kg/m

K527

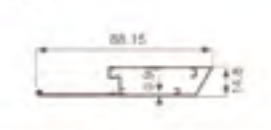

壁厚: 0.9mm 米重: 0.543kg/m

K528



壁厚: 1.0mm 米重: 0.224kg/m

K529

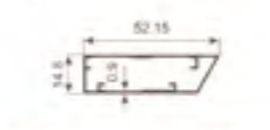

壁厚: 0.9mm 米重: 0.396kg/m

K530

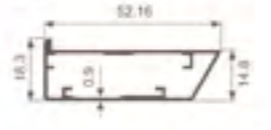

壁厚: 0.9mm 米重: 0.415kg/m

K619

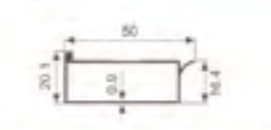

壁厚: 0.9mm 米重: 0.330kg/m

K624

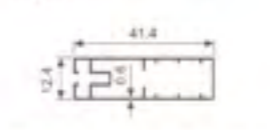

壁厚: 0.6mm 米重: 0.230kg/m

K625

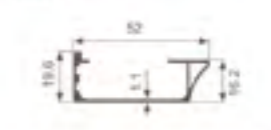

壁厚: 1.1mm 米重: 0.370kg/m

K626

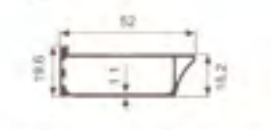

壁厚: 1.1mm 米重: 0.510kg/m

K531

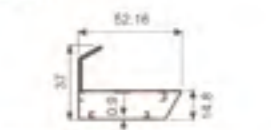

壁厚: 0.9mm 米重: 0.540kg/m

K543

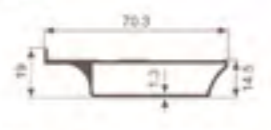

壁厚: 1.1mm 米重: 0.580kg/m

K544

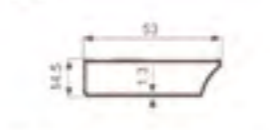

壁厚: 1.1mm 米重: 0.428kg/m

K546

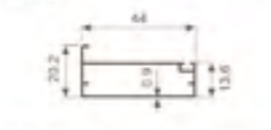

壁厚: 0.9mm 米重: 0.319kg/m

K627

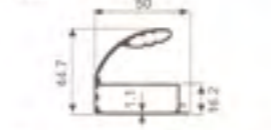

壁厚: 1.1mm 米重: 0.790kg/m

K628

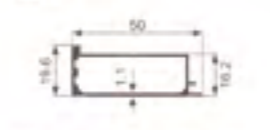

壁厚: 1.1mm 米重: 0.426kg/m

K629

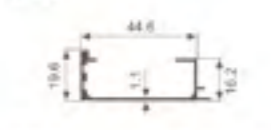

壁厚: 1.1mm 米重: 0.337kg/m

K639

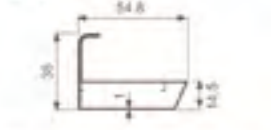

壁厚: 1.0mm 米重: 0.542kg/m

<p>K640</p> <p>壁厚: 1.0mm 米重: 0.397kg/m</p>	<p>K642</p> <p>壁厚: 1.4mm 米重: 0.571kg/m</p>	<p>K646</p> <p>壁厚: 1.0mm 米重: 0.406kg/m</p>	<p>K524A</p> <p>壁厚: 1.1mm 米重: 0.394kg/m</p>	<p>K934</p> <p>壁厚: 1.3mm 米重: 0.670kg/m</p>	<p>K936</p> <p>壁厚: 1.9mm 米重: 0.870kg/m</p>	<p>K937</p> <p>壁厚: 1.5mm 米重: 0.628kg/m</p>	<p>K938</p> <p>壁厚: 1.5mm 米重: 0.845kg/m</p>
<p>K655</p> <p>壁厚: 1.0mm 米重: 0.489kg/m</p>	<p>K656</p> <p>壁厚: 1.0mm 米重: 0.332kg/m</p>	<p>K671</p> <p>壁厚: 0.5mm 米重: 0.159kg/m</p>	<p>K675</p> <p>壁厚: 0.5mm 米重: 0.152kg/m</p>	<p>K940</p> <p>壁厚: 1.5mm 米重: 0.577kg/m</p>	<p>K941</p> <p>壁厚: 1.5mm 米重: 0.767kg/m</p>	<p>K942</p> <p>壁厚: 1.5mm 米重: 0.818kg/m</p>	<p>K1026</p> <p>壁厚: 1.1mm 米重: 0.540kg/m</p>
<p>K686</p> <p>壁厚: 1.0mm 米重: 0.485kg/m</p>	<p>K691</p> <p>壁厚: 1.0mm 米重: 0.428kg/m</p>	<p>K692</p> <p>壁厚: 1.0mm 米重: 0.629kg/m</p>	<p>K708</p> <p>壁厚: 1.0mm 米重: 0.426kg/m</p>	<p>K1132</p> <p>壁厚: 1.0mm 米重: 0.410kg/m</p>	<p>K1133</p> <p>壁厚: 1.0mm 米重: 0.357kg/m</p>	<p>K1208</p> <p>壁厚: 1.15mm 米重: 0.537kg/m</p>	<p>K1209</p> <p>壁厚: 1.15mm 米重: 0.329kg/m</p>
<p>K710</p> <p>壁厚: 1.0mm 米重: 0.414kg/m</p>	<p>K714</p> <p>壁厚: 1.0mm 米重: 0.325kg/m</p>	<p>K727</p> <p>壁厚: 1.1mm 米重: 0.586kg/m</p>	<p>K736</p> <p>壁厚: 1.5mm 米重: 0.710kg/m</p>	<p>K1265</p> <p>壁厚: 0.9mm 米重: 0.437kg/m</p>	<p>K1270</p> <p>壁厚: 0.9mm 米重: 0.435kg/m</p>	<p>K1274</p> <p>壁厚: 1.3mm 米重: 0.519kg/m</p>	<p>K1275</p> <p>壁厚: 1.3mm 米重: 0.620kg/m</p>
<p>K737</p> <p>壁厚: 1.1mm 米重: 0.396kg/m</p>	<p>K740</p> <p>壁厚: 0.6mm 米重: 0.294kg/m</p>	<p>K749</p> <p>壁厚: 1.0mm 米重: 0.475kg/m</p>	<p>K754</p> <p>壁厚: 0.5mm 米重: 0.193kg/m</p>	<p>K1276</p> <p>壁厚: 1.3mm 米重: 0.510kg/m</p>	<p>K1277</p> <p>壁厚: 1.3mm 米重: 0.632kg/m</p>	<p>K1278</p> <p>壁厚: 1.3mm 米重: 0.618kg/m</p>	<p>K1279</p> <p>壁厚: 1.3mm 米重: 0.650kg/m</p>
<p>K756</p> <p>壁厚: 1.0mm 米重: 0.373kg/m</p>	<p>K757</p> <p>壁厚: 1.0mm 米重: 0.624kg/m</p>	<p>K758</p> <p>壁厚: 1.0mm 米重: 0.555kg/m</p>	<p>K767</p> <p>壁厚: 1.1mm 米重: 0.314kg/m</p>	<p>K1283</p> <p>壁厚: 1.2mm 米重: 0.580kg/m</p>	<p>K1284</p> <p>壁厚: 1.2mm 米重: 0.454kg/m</p>	<p>K1285</p> <p>壁厚: 1.2mm 米重: 0.439kg/m</p>	<p>K1291</p> <p>壁厚: 1.2mm 米重: 0.497kg/m</p>
<p>K825</p> <p>壁厚: 1.0mm 米重: 0.591kg/m</p>	<p>K931</p> <p>壁厚: 1.0mm 米重: 0.364kg/m</p>	<p>K932</p> <p>壁厚: 1.0mm 米重: 0.505kg/m</p>	<p>K933</p> <p>壁厚: 1.3mm 米重: 0.497kg/m</p>	<p>K1292</p> <p>壁厚: 1.2mm 米重: 0.609kg/m</p>	<p>K1293</p> <p>壁厚: 1.2mm 米重: 0.617kg/m</p>	<p>K1294</p> <p>壁厚: 1.2mm 米重: 0.483kg/m</p>	<p>K1295</p> <p>壁厚: 1.2mm 米重: 0.584kg/m</p>

<p>K1296</p> <p>壁厚: 1.2mm 米重: 0.604kg/m</p>	<p>K1297</p> <p>壁厚: 1.2mm 米重: 0.516kg/m</p>	<p>K1298</p> <p>壁厚: 1.2mm 米重: 0.616kg/m</p>	<p>K1304</p> <p>壁厚: 1.2mm 米重: 0.763kg/m</p>	<p>K1364</p> <p>壁厚: 1.0mm 米重: 0.522kg/m</p>	<p>K1396</p> <p>壁厚: 1.2mm 米重: 0.636kg/m</p>	<p>K1363</p> <p>壁厚: 1.0mm 米重: 0.359kg/m</p>	<p>K1410</p> <p>壁厚: 1.2mm 米重: 0.571kg/m</p>
<p>K1305</p> <p>壁厚: 1.2mm 米重: 0.524kg/m</p>	<p>K1306</p> <p>壁厚: 1.3mm 米重: 0.604kg/m</p>	<p>K1315</p> <p>壁厚: 1.2mm 米重: 0.555kg/m</p>	<p>K1316</p> <p>壁厚: 1.2mm 米重: 0.430kg/m</p>	<p>K1800</p> <p>壁厚: 1.3mm 米重: 0.476kg/m</p>	<p>K1801</p> <p>壁厚: 1.3mm 米重: 0.653kg/m</p>	<p>K1802</p> <p>壁厚: 1.3mm 米重: 0.557kg/m</p>	<p>K1530</p> <p>壁厚: 1.2mm 米重: 0.541kg/m</p>
<p>K1328</p> <p>壁厚: 1.2mm 米重: 0.630kg/m</p>	<p>K1344</p> <p>壁厚: 1.3mm 米重: 0.625kg/m</p>	<p>K1345</p> <p>壁厚: 1.3mm 米重: 0.461kg/m</p>	<p>K1348</p> <p>壁厚: 1.3mm 米重: 0.643kg/m</p>	<p>K1531</p> <p>壁厚: 1.2mm 米重: 0.625kg/m</p>	<p>K1543</p> <p>壁厚: 1.0mm 米重: 0.426kg/m</p>	<p>A01</p> <p>壁厚: 1.0mm 米重: 0.390kg/m</p>	<p>K1544</p> <p>壁厚: 1.0mm 米重: 0.501kg/m</p>
<p>K1349</p> <p>壁厚: 1.3mm 米重: 0.467kg/m</p>	<p>K1350</p> <p>壁厚: 1.3mm 米重: 0.604kg/m</p>	<p>K1351</p> <p>壁厚: 1.3mm 米重: 0.447kg/m</p>	<p>K1352</p> <p>壁厚: 1.3mm 米重: 0.553kg/m</p>	<p>K1803</p> <p>壁厚: 1.3mm 米重: 0.829kg/m</p>	<p>K1804</p> <p>壁厚: 1.3mm 米重: 0.604kg/m</p>	<p>K1543A</p> <p>壁厚: 1.0mm 米重: 0.453kg/m</p>	<p>K1544A</p> <p>壁厚: 1.0mm 米重: 0.527kg/m</p>
<p>XGG-1292</p> <p>壁厚: 1.0mm 米重: 0.397kg/m</p>	<p>XGY-2393</p> <p>壁厚: 1.0mm 米重: 0.366kg/m</p>	<p>XGY-2394</p> <p>壁厚: 1.0mm 米重: 0.429kg/m</p>	<p>XGY-2395</p> <p>壁厚: 1.0mm 米重: 0.447kg/m</p>	<p>K1514</p> <p>壁厚: 1.4mm 米重: 0.657kg/m</p>	<p>K1513</p> <p>壁厚: 1.4mm 米重: 0.486kg/m</p>	<p>K1514A</p> <p>壁厚: 1.4mm 米重: 0.626kg/m</p>	<p>XGG-1540</p> <p>壁厚: 1.0mm 米重: 0.397kg/m</p>
<p>XGY-2396</p> <p>壁厚: 1.0mm 米重: 0.453kg/m</p>	<p>K1373</p> <p>壁厚: 1.3mm 米重: 0.719kg/m</p>	<p>K1368</p> <p>壁厚: 1.3mm 米重: 0.653kg/m</p>	<p>MY-A694</p> <p>壁厚: 1.3mm 米重: 0.815kg/m</p>	<p>K1516</p> <p>壁厚: 1.4mm 米重: 0.702kg/m</p>	<p>K1515</p> <p>壁厚: 1.4mm 米重: 0.529kg/m</p>	<p>K1603</p> <p>壁厚: 1.1mm 米重: 0.579kg/m</p>	<p>K1604</p> <p>壁厚: 1.1mm 米重: 0.412kg/m</p>
<p>K1367</p> <p>壁厚: 1.3mm 米重: 0.579kg/m</p>	<p>MY-A693</p> <p>壁厚: 1.3mm 米重: 0.673kg/m</p>	<p>K1366</p> <p>壁厚: 1.3mm 米重: 0.449kg/m</p>	<p>K1395</p> <p>壁厚: 0.9mm 米重: 0.519kg/m</p>	<p>K1609</p> <p>壁厚: 1.1mm 米重: 0.716kg/m</p>	<p>K1610</p> <p>壁厚: 1.1mm 米重: 0.482kg/m</p>	<p>A1920</p> <p>壁厚: 0.9mm 米重: 0.354kg/m</p>	<p>A1731</p> <p>壁厚: 1.2mm 米重: 0.376kg/m</p>

<p>K2062</p> <p>壁厚: 1.5mm 重量: 0.656kg/m</p>	<p>K2063</p> <p>壁厚: 5.0mm 重量: 0.130kg/m</p>	<p>K1685</p> <p>壁厚: 1.1mm 重量: 0.194kg/m</p>	<p>K1326T</p> <p>壁厚: 1.2mm 重量: 0.447kg/m</p>	<p>A22-37</p> <p>壁厚: 1.1mm 重量: 0.426kg/m</p>	<p>K1521</p> <p>壁厚: 1.2mm 重量: 0.478kg/m</p>	<p>K1383</p> <p>壁厚: 1.2mm 重量: 0.636kg/m</p>	<p>K1846</p> <p>壁厚: 1.2mm 重量: 0.760kg/m</p>
<p>XGG-1540</p> <p>壁厚: 1.6mm 重量: 0.194kg/m</p>	<p>K1696</p> <p>壁厚: 1.4mm 重量: 0.661kg/m</p>	<p>K1697</p> <p>壁厚: 1.4mm 重量: 0.462kg/m</p>	<p>K1421</p> <p>壁厚: 0.9mm 重量: 0.117kg/m</p>	<p>K2056</p> <p>壁厚: 1.2mm 重量: 0.760kg/m</p>	<p>K2057</p> <p>壁厚: 1.2mm 重量: 0.587kg/m</p>	<p>K2058</p> <p>壁厚: 1.2mm 重量: 0.406kg/m</p>	<p>K2130</p> <p>壁厚: 1.7mm 重量: 0.701kg/m</p>
<p>K1423</p> <p>壁厚: 1.0mm 重量: 0.427kg/m</p>	<p>K1424</p> <p>壁厚: 1.0mm 重量: 0.556kg/m</p>	<p>K1425</p> <p>壁厚: 1.0mm 重量: 0.174kg/m</p>	<p>K1427</p> <p>壁厚: 1.2mm 重量: 0.189kg/m</p>	<p>K2131</p> <p>壁厚: 0.7mm 重量: 0.250kg/m</p>	<p>K2085</p> <p>壁厚: 1.2mm 重量: 0.580kg/m</p>	<p>K2084</p> <p>壁厚: 1.2mm 重量: 0.442kg/m</p>	<p>K2059</p> <p>壁厚: 1.0mm 重量: 0.479kg/m</p>
<p>K1430</p> <p>壁厚: 1.4mm 重量: 0.533kg/m</p>	<p>K1431</p> <p>壁厚: 1.1mm 重量: 0.501kg/m</p>	<p>K1432</p> <p>壁厚: 1.3mm 重量: 0.542kg/m</p>	<p>K1436</p> <p>壁厚: 1.2mm 重量: 0.463kg/m</p>	<p>K2088</p> <p>壁厚: 1.0mm 重量: 0.172kg/m</p>	<p>K2115</p> <p>壁厚: 1.2mm 重量: 0.817kg/m</p>	<p>K2116</p> <p>壁厚: 1.2mm 重量: 0.461kg/m</p>	<p>K2117</p> <p>壁厚: 1.2mm 重量: 0.581kg/m</p>
<p>K1438</p> <p>壁厚: 1.1mm 重量: 0.626kg/m</p>	<p>K1469</p> <p>壁厚: 0.8mm 重量: 0.554kg/m</p>	<p>K1470</p> <p>壁厚: 0.8mm 重量: 0.180kg/m</p>	<p>K1442</p> <p>壁厚: 1.3mm 重量: 0.728kg/m</p>	<p>K2118</p> <p>壁厚: 1.2mm 重量: 0.429kg/m</p>	<p>K2119</p> <p>壁厚: 1.2mm 重量: 0.597kg/m</p>	<p>K2120</p> <p>壁厚: 1.2mm 重量: 0.483kg/m</p>	<p>K1377</p> <p>壁厚: 1.2mm 重量: 0.650kg/m</p>
<p>K1447</p> <p>壁厚: 1.7mm 重量: 0.456kg/m</p>	<p>K1446</p> <p>壁厚: 1.1mm 重量: 0.109kg/m</p>	<p>A22-37</p> <p>壁厚: 1.1mm 重量: 0.426kg/m</p>	<p>K1477</p> <p>壁厚: 1.1mm 重量: 0.442kg/m</p>	<p>K1378</p> <p>壁厚: 1.2mm 重量: 0.490kg/m</p>	<p>HK2134</p> <p>壁厚: 1.1mm 重量: 0.618kg/m</p>	<p>HK2133</p> <p>壁厚: 1.2mm 重量: 0.467kg/m</p>	<p>K1265</p> <p>壁厚: 0.9mm 重量: 0.437kg/m</p>
<p>K1478</p> <p>壁厚: 1.1mm 重量: 0.495kg/m</p>	<p>K1481</p> <p>壁厚: 1.0mm 重量: 0.423kg/m</p>	<p>K1492</p> <p>壁厚: 1.0mm 重量: 0.500kg/m</p>	<p>K1487</p> <p>壁厚: 1.1mm 重量: 0.707kg/m</p>	<p>K1367</p> <p>壁厚: 1.3mm 重量: 0.579kg/m</p>	<p>K1368</p> <p>壁厚: 1.3mm 重量: 0.653kg/m</p>	<p>K1411</p> <p>壁厚: 1.2mm 重量: 0.446kg/m</p>	

K1415(A29-92)



壁厚: 1.2mm 重量: 0.148kg/m

XGY-482



壁厚: 1.0mm 重量: 0.199kg/m

K1416



壁厚: 2.0mm 重量: 0.179kg/m

K2166(A29-34)



壁厚: 0.8mm 重量: 0.121kg/m

G3235

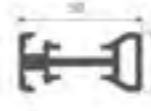

壁厚: 2.0mm 重量: 0.284kg/m

G3236



壁厚: 1.4mm 重量: 0.209kg/m

G3237



壁厚: 1.5mm 重量: 0.276kg/m

K1385

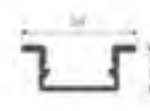

壁厚: 0.8mm 重量: 0.120kg/m

K2161(A29-29)



壁厚: 0.7mm 重量: 0.207kg/m

K2166(A29-34)



壁厚: 1.0mm 重量: 0.213kg/m

K2250



壁厚: 1.0mm 重量: 0.132kg/m

K1504



壁厚: 2.0mm 重量: 0.554kg/m

K1386



壁厚: 0.8mm 重量: 0.081kg/m

K1387



壁厚: 0.8mm 重量: 0.107kg/m

K1388

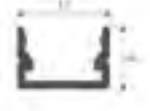

壁厚: 0.5mm 重量: 0.029kg/m

K1389

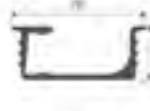

壁厚: 0.8mm 重量: 0.150kg/m

K1505



壁厚: 2.0mm 重量: 0.588kg/m

K1958

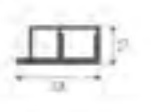

壁厚: 1.2mm 重量: 0.467kg/m

K1959



壁厚: 1.2mm 重量: 0.479kg/m

K1963(FW003D)



壁厚: 0.8mm 重量: 0.172kg/m

K1309



壁厚: 1.0mm 重量: 0.153kg/m

K1339

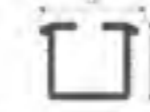

壁厚: 1.0mm 重量: 0.153kg/m

K1418

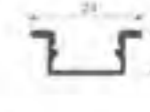

壁厚: 0.7mm 重量: 0.117kg/m

K1507

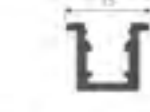

壁厚: 1.2mm 重量: 0.146kg/m

K1964(WZY003A)



壁厚: 0.7mm 重量: 0.160kg/m

K1965(WZY003C)



壁厚: 0.8mm 重量: 0.196kg/m

K1966(WZY003B)



壁厚: 0.8mm 重量: 0.211kg/m

K1976(WZY003C)



壁厚: 1.0mm 重量: 0.254kg/m

K1551

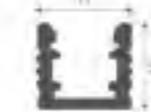

壁厚: 1.0mm 重量: 0.108kg/m

K1595



壁厚: 1.0mm 重量: 0.103kg/m

K1596



壁厚: 0.8mm 重量: 0.124kg/m

K1597



壁厚: 1.0mm 重量: 0.273kg/m

K1977(WZY003D)



壁厚: 1.2mm 重量: 0.270kg/m

K3286



壁厚: 1.0mm 重量: 0.250kg/m

K3287



壁厚: 1.2mm 重量: 0.403kg/m

K3288



壁厚: 1.0mm 重量: 0.329kg/m

K1598



壁厚: 1.2mm 重量: 0.234kg/m

K1599



壁厚: 1.0mm 重量: 0.151kg/m

XGG-1479



壁厚: 1.4mm 重量: 0.117kg/m

XGG-1482

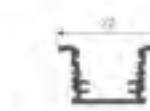

壁厚: 1.4mm 重量: 0.130kg/m

K2219

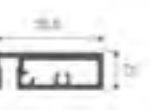

壁厚: 1.5mm 重量: 0.499kg/m

K2220

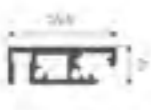

壁厚: 1.5mm 重量: 0.499kg/m

K2211



壁厚: 1.0mm 重量: 0.264kg/m

K2212



壁厚: 1.0mm 重量: 0.264kg/m

K1612



壁厚: 1.2mm 重量: 0.255kg/m

K1994



壁厚: 1.0mm 重量: 0.103kg/m

K2207



壁厚: 0.7mm 重量: 0.026kg/m

K2234



壁厚: 0.8mm 重量: 0.100kg/m

K2213



壁厚: 1.4mm 重量: 0.214kg/m

K2214



壁厚: 1.4mm 重量: 0.209kg/m

G3172



壁厚: 1.3mm 重量: 0.204kg/m

G3173

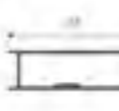

壁厚: 1.3mm 重量: 0.403kg/m

K1643



壁厚: 1.0mm 重量: 0.110kg/m

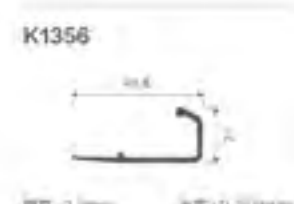
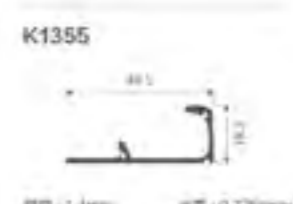
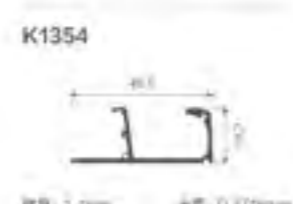
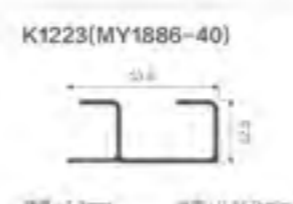
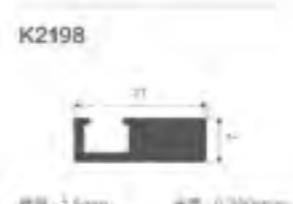
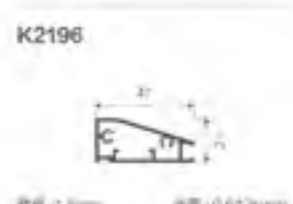
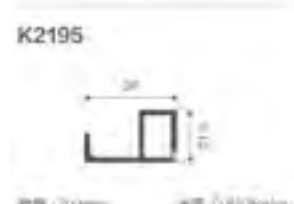
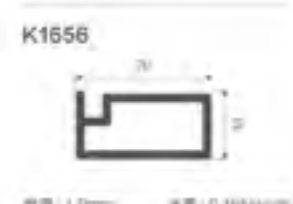
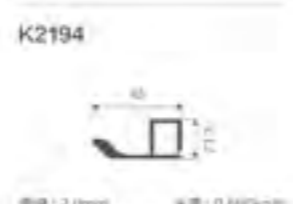
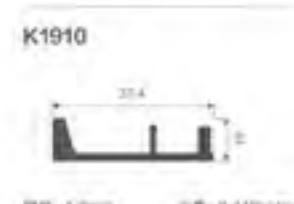
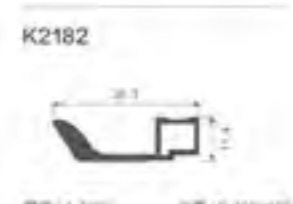
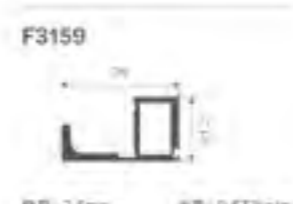
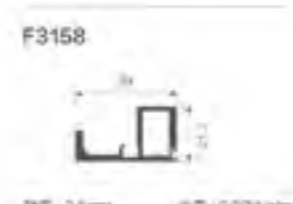
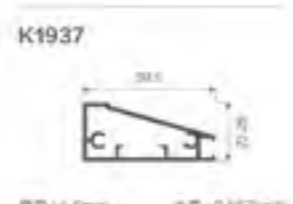
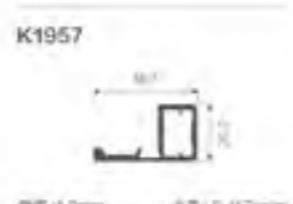
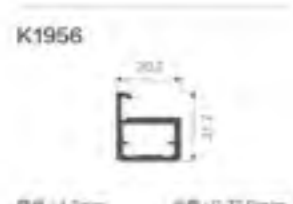
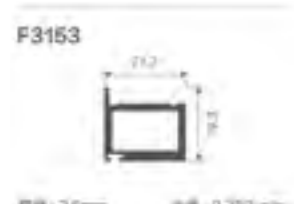
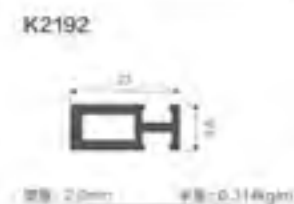
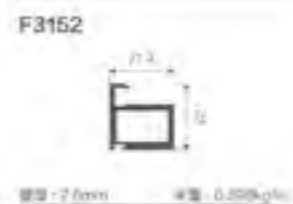
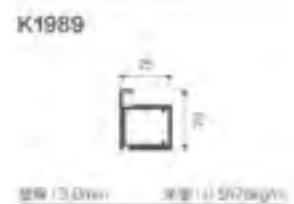
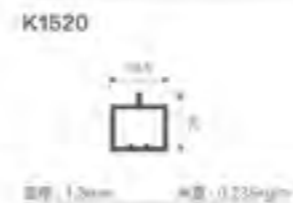
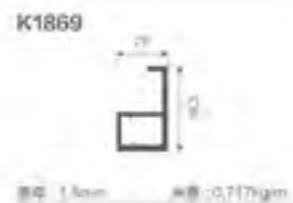
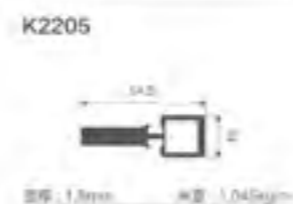
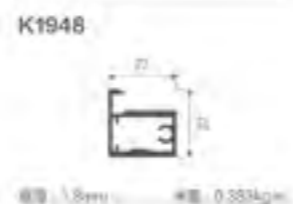
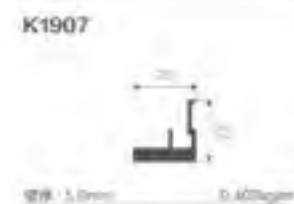
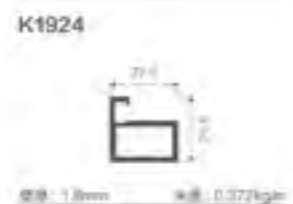
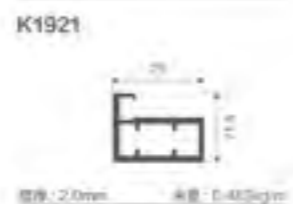
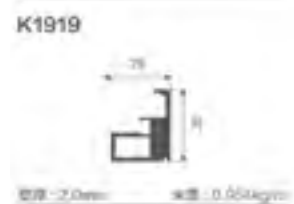

A25-60



壁厚: 1.7mm 重量: 0.55kg/m

A25-61

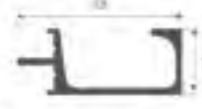

壁厚: 1.8mm 重量: 0.46kg/m

A25-62

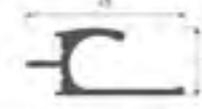

壁厚: 1.8mm 重量: 0.44kg/m

MY-A30



壁厚: 2.0mm 重量: 0.59kg/m

K1978

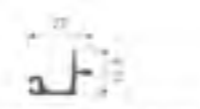

壁厚: 1.5mm 重量: 0.25kg/m

K1390



壁厚: 1.7mm 重量: 0.29kg/m

MY-A536S(A31-37)

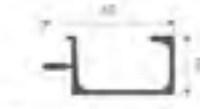

壁厚: 1.3mm 重量: 0.32kg/m

K2149

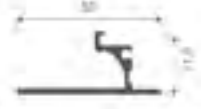

壁厚: 2.2mm 重量: 0.42kg/m

K1889

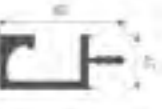

壁厚: 1.9mm 重量: 1.44kg/m

K1912

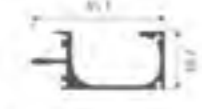

壁厚: 1.3mm 重量: 0.452kg/m

K1892

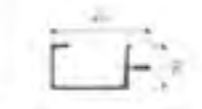

壁厚: 1.1mm 重量: 0.21kg/m

K1893



壁厚: 1.5mm 重量: 0.236kg/m

K1772

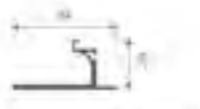

壁厚: 2.6mm 重量: 0.544kg/m

K1918

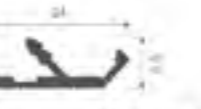

壁厚: 1.5mm 重量: 0.124kg/m

K2181



壁厚: 2.0mm 重量: 0.269kg/m

K1456



壁厚: 1.4mm 重量: 0.21kg/m

K1835(A31-97)

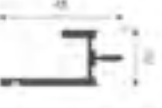

壁厚: 2.4mm 重量: 0.412kg/m

K1931

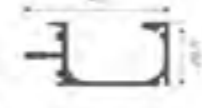

壁厚: 1.3mm 重量: 0.471kg/m

K1978

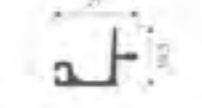

壁厚: 1.5mm 重量: 0.25kg/m

K3305

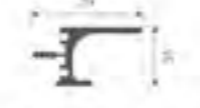

壁厚: 2.0mm 重量: 1.3kg/m

K1457

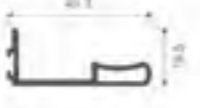

壁厚: 2.0mm 重量: 0.404kg/m

K1458

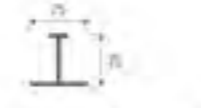

壁厚: 1.4mm 重量: 0.176kg/m

K1773



壁厚: 1.2mm 重量: 0.347kg/m

K1774



壁厚: 1.2mm 重量: 0.22kg/m

K3306

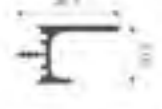

壁厚: 1.8mm 重量: 0.343kg/m

K1669

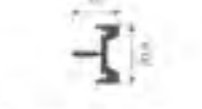

壁厚: 2.0mm 重量: 0.242kg/m

K1669A

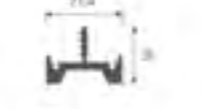

壁厚: 2.0mm 重量: 0.249kg/m

K1708

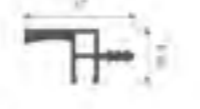

壁厚: 1.3mm 重量: 0.442kg/m

K1929



壁厚: 1.2mm 重量: 0.238kg/m

K1930

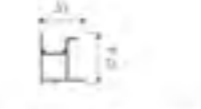

壁厚: 1.2mm 重量: 0.236kg/m

K2202



壁厚: 2.7mm 重量: 0.419kg/m

K2203



壁厚: 2.7mm 重量: 0.407kg/m

K1642



壁厚: 1.5mm 重量: 0.272kg/m

K1663



壁厚: 3.0mm 重量: 0.738kg/m

K1575

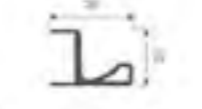

壁厚: 1.3mm 重量: 0.315kg/m

K1506

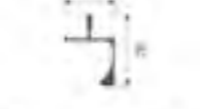

壁厚: 2.0mm 重量: 0.494kg/m

K1975



壁厚: 1.8mm 重量: 0.482kg/m

K1476

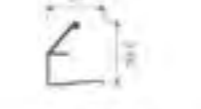

壁厚: 1.6mm 重量: 0.254kg/m

K1456A

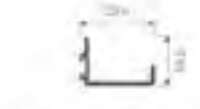

壁厚: 1.4mm 重量: 0.167kg/m

K1457A

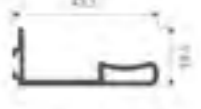

壁厚: 2.0mm 重量: 0.404kg/m

K1967(ZB-SQA182)



壁厚: 1.9mm 重量: 0.277kg/m

K1210



壁厚: 1.5mm 重量: 0.448kg/m

K1917/A31-99



壁厚: 1.2mm 重量: 0.199kg/m

K1931

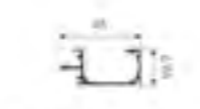

壁厚: 1.3mm 重量: 0.421kg/m

K1458A



壁厚: 1.4mm 重量: 0.199kg/m

K1953

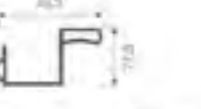

壁厚: 1.6mm 重量: 1.2kg/m

K1954

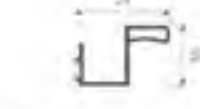

壁厚: 1.6mm 重量: 1.45kg/m

K1950

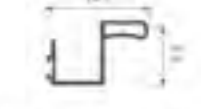

壁厚: 0.8mm 重量: 0.114kg/m

K1936

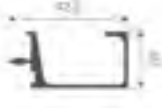

壁厚: 1.2mm 重量: 0.334kg/m

K3540(K3082)



壁厚: 2.0mm 重量: 0.268kg/m

K1945



壁厚: 1.3mm 重量: 0.272kg/m

K1913

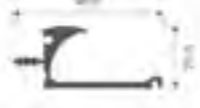

壁厚: 2.0mm 重量: 0.591kg/m

MY-A644S



壁厚: 2.0mm 重量: 0.446kg/m

MY-A645S



壁厚: 2.0mm 重量: 0.504kg/m

K3307

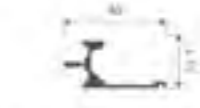

壁厚: 1.0mm 重量: 0.233kg/m

K3308

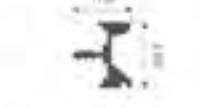

壁厚: 1.2mm 重量: 0.266kg/m

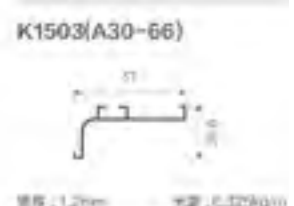
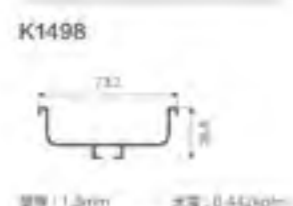
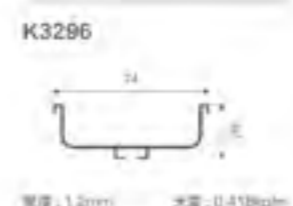
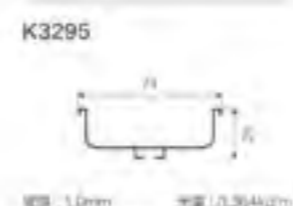
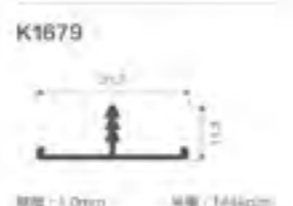
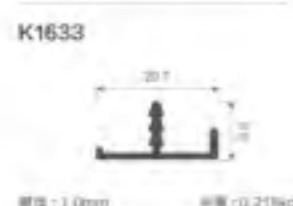
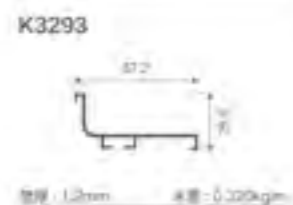
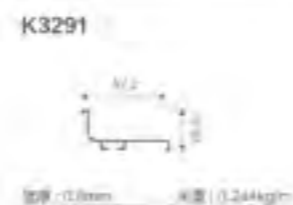
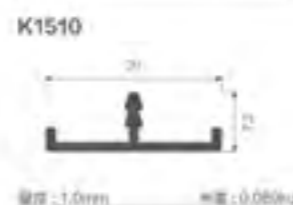
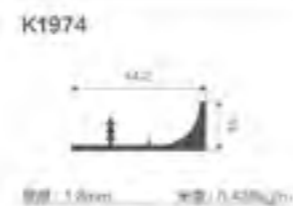
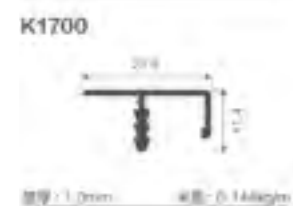
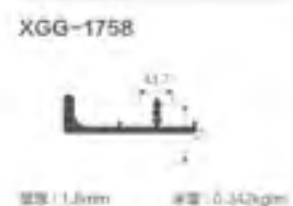
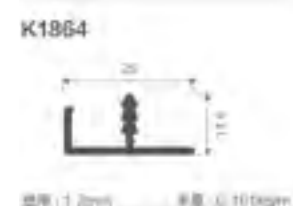
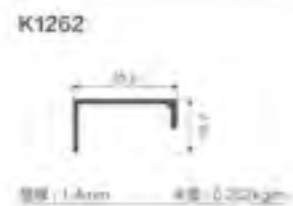
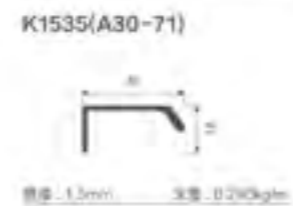
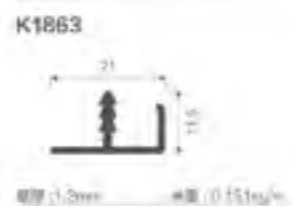
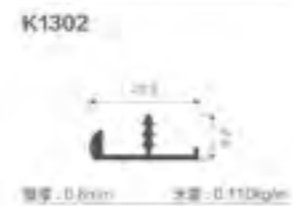
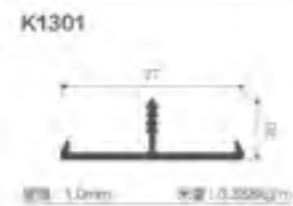
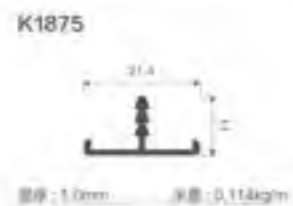
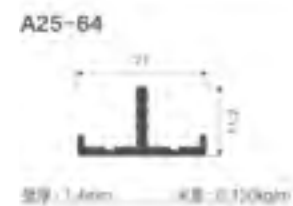
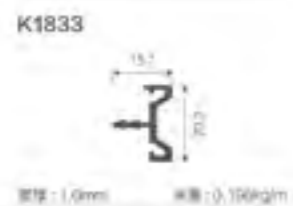

<p>K3201(A30-67)</p> <p>壁厚: 1.0mm 重量: 0.41kg/m</p>	<p>A26-52</p> <p>壁厚: 1.0mm 重量: 0.09kg/m</p>	<p>K1865(30-40)</p> <p>壁厚: 1.0mm 重量: 0.53kg/m</p>	<p>K1866(A30-41)</p> <p>壁厚: 1.0mm 重量: 0.50kg/m</p>	<p>K1426</p> <p>壁厚: 1.2mm 重量: 0.26kg/m</p>	<p>K1428</p> <p>壁厚: 1.2mm 重量: 0.54kg/m</p>	<p>K1903</p> <p>壁厚: 1.0mm 重量: 0.54kg/m</p>	<p>K1904</p> <p>壁厚: 1.0mm 重量: 0.70kg/m</p>
<p>K1371</p> <p>壁厚: 1.3mm 重量: 0.35kg/m</p>	<p>K1503</p> <p>壁厚: 1.2mm 重量: 0.70kg/m</p>	<p>K3201</p> <p>壁厚: 1.2mm 重量: 0.41kg/m</p>	<p>K1608</p> <p>壁厚: 1.2mm 重量: 0.05kg/m</p>	<p>K1932</p> <p>壁厚: 1.0mm 重量: 0.53kg/m</p>	<p>K1933</p> <p>壁厚: 1.0mm 重量: 0.87kg/m</p>	<p>K1935</p> <p>壁厚: 1.2mm 重量: 0.54kg/m</p>	<p>MY0328</p> <p>壁厚: 1.0mm 重量: 0.28kg/m</p>
<p>K1607</p> <p>壁厚: 1.2mm 重量: 0.59kg/m</p>	<p>K625</p> <p>壁厚: 1.2mm 重量: 0.25kg/m</p>	<p>K1626</p> <p>壁厚: 1.2mm 重量: 0.73kg/m</p>	<p>K1286 (A28-86)</p> <p>壁厚: 1.5mm 重量: 0.97kg/m</p>	<p>MY0329</p> <p>壁厚: 1.5mm 重量: 0.54kg/m</p>	<p>K1800</p> <p>壁厚: 1.3mm 重量: 0.47kg/m</p>	<p>K1801</p> <p>壁厚: 1.3mm 重量: 0.65kg/m</p>	<p>K1802</p> <p>壁厚: 1.3mm 重量: 0.50kg/m</p>
<p>K1287(A28-87)</p> <p>壁厚: 1.5mm 重量: 1.09kg/m</p>	<p>K1288(A28-88)</p> <p>壁厚: 1.5mm 重量: 1.42kg/m</p>	<p>K1289(A28-89)</p> <p>壁厚: 1.5mm 重量: 1.27kg/m</p>		<p>K1803</p> <p>壁厚: 1.3mm 重量: 0.52kg/m</p>	<p>K1804</p> <p>壁厚: 1.3mm 重量: 0.62kg/m</p>	<p>K1890</p> <p>壁厚: 1.0mm 重量: 0.50kg/m</p>	<p>K1891</p> <p>壁厚: 1.0mm 重量: 0.41kg/m</p>
<p>K1375</p> <p>壁厚: 1.2mm 重量: 0.68kg/m</p>	<p>K1376</p> <p>壁厚: 1.2mm 重量: 0.51kg/m</p>	<p>K1379</p> <p>壁厚: 1.2mm 重量: 0.66kg/m</p>	<p>K1380</p> <p>壁厚: 1.2mm 重量: 0.481kg/m</p>	<p>K1840(A31-13)</p> <p>壁厚: 1.3mm 重量: 0.507kg/m</p>	<p>K1841(A31-14)</p> <p>壁厚: 1.8mm 重量: 0.57kg/m</p>	<p>K1842(A31-15)</p> <p>壁厚: 1.2mm 重量: 0.72kg/m</p>	<p>K1514A</p> <p>壁厚: 1.4mm 重量: 0.67kg/m</p>
<p>K1360</p> <p>壁厚: 1.2mm 重量: 0.48kg/m</p>	<p>K1361</p> <p>壁厚: 1.2mm 重量: 0.52kg/m</p>	<p>K1329</p> <p>壁厚: 1.2mm 重量: 0.43kg/m</p>	<p>K1330</p> <p>壁厚: 1.2mm 重量: 0.275kg/m</p>	<p>A206A</p> <p>壁厚: 1.2mm 重量: 0.287kg/m</p>	<p>A1763</p> <p>壁厚: 1.2mm 重量: 0.401kg/m</p>	<p>K1851</p> <p>壁厚: 1.0mm 重量: 0.34kg/m</p>	<p>K1852</p> <p>壁厚: 1.4mm 重量: 0.64kg/m</p>
<p>K1312</p> <p>壁厚: 1.5mm 重量: 0.26kg/m</p>	<p>K1313</p> <p>壁厚: 1.2mm 重量: 0.52kg/m</p>	<p>K1412</p> <p>壁厚: 1.3mm 重量: 0.35kg/m</p>	<p>K1413</p> <p>壁厚: 1.0mm 重量: 0.371kg/m</p>	<p>K1853</p> <p>壁厚: 1.4mm 重量: 0.47kg/m</p>	<p>K1854</p> <p>壁厚: 1.4mm 重量: 0.49kg/m</p>	<p>MY-A673S(A31-35)</p> <p>壁厚: 1.2mm 重量: 0.62kg/m</p>	<p>MY-A683S(A31-36)</p> <p>壁厚: 1.2mm 重量: 0.71kg/m</p>

MY-A656S(A31-38)

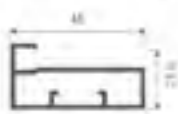

壁厚: 1.2mm 重量: 0.461kg/m

MY-A684S(A31-39)

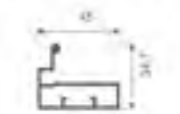

壁厚: 1.2mm 重量: 0.543kg/m

A25-59

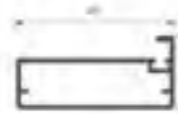

壁厚: 1.2mm 重量: 0.44kg/m

K1988

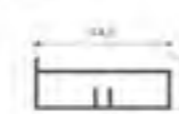

壁厚: 1.0mm 重量: 0.44kg/m

K1842

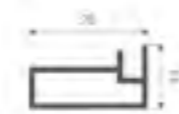

壁厚: 1.0mm 重量: 0.157kg/m

K1843



壁厚: 1.3mm 重量: 0.029kg/m

K1615



壁厚: 1.0mm 重量: 0.219kg/m

K1568

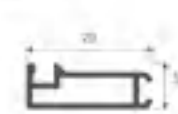

壁厚: 1.0mm 重量: 0.213kg/m

K1908

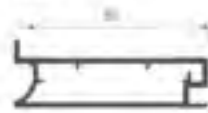

壁厚: 1.5mm 重量: 0.58kg/m

K1909

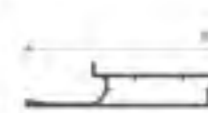

壁厚: 1.5mm 重量: 0.25kg/m

A401



壁厚: 1.5mm 重量: 0.599kg/m

MY-A655S

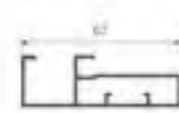

壁厚: 1.2mm 重量: 0.602kg/m

K1569



壁厚: 0.8mm 重量: 0.035kg/m

K1311

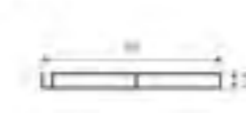

壁厚: 0.6mm 重量: 0.061kg/m

MY-A656S

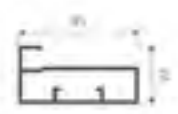

壁厚: 1.2mm 重量: 0.460kg/m

K1857

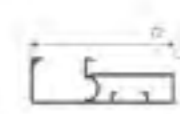

壁厚: 1.2mm 重量: 0.671kg/m

K1979

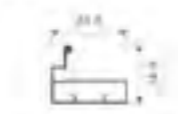

壁厚: 1.3mm 重量: 0.04kg/m

K1986

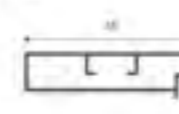

壁厚: 1.0mm 重量: 0.33kg/m

K1237



壁厚: 1.0mm 重量: 0.09kg/m

K1238

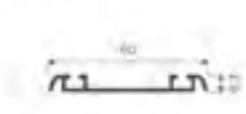

壁厚: 1.2mm 重量: 0.208kg/m

K1307



壁厚: 1.2mm 重量: 0.219kg/m

K1308

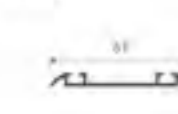

壁厚: 1.2mm 重量: 0.208kg/m

K1987



壁厚: 1.0mm 重量: 0.49kg/m

K1951

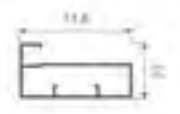

壁厚: 1.5mm 重量: 0.299kg/m

K1952

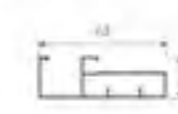

壁厚: 1.1mm 重量: 0.54kg/m

K1995

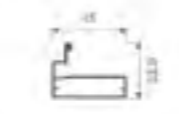

壁厚: 1.2mm 重量: 0.602kg/m

K1526



壁厚: 1.2mm 重量: 0.471kg/m

K1527



壁厚: 1.0mm 重量: 0.202kg/m

K1528

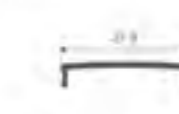

壁厚: 1.0mm 重量: 0.000kg/m

K1500

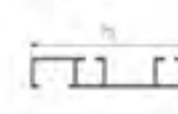

壁厚: 1.2mm 重量: 0.473kg/m

K1996

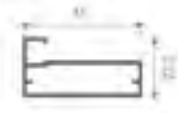

壁厚: 1.2mm 重量: 0.443kg/m

K1997

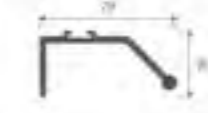

壁厚: 2.0mm 重量: 0.411kg/m

K2121

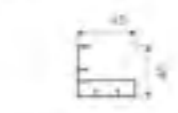

壁厚: 2.0mm 重量: 0.111kg/m

K1901(A31-92)

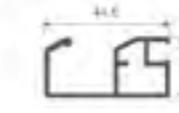

壁厚: 1.2mm 重量: 0.46kg/m

K1501

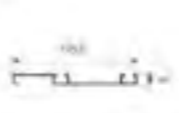

壁厚: 1.0mm 重量: 0.207kg/m

K1502



壁厚: 1.0mm 重量: 0.000kg/m

K1463A

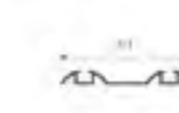

壁厚: 1.2mm 重量: 0.314kg/m

K1462



壁厚: 1.4mm 重量: 0.293kg/m

K1902(A31-93)



壁厚: 2.0mm 重量: 0.151kg/m

K2183

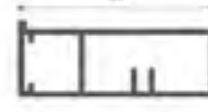

壁厚: 1.0mm 重量: 0.409kg/m

K1998

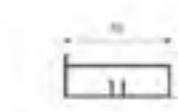

壁厚: 1.2mm 重量: 0.420kg/m

K1999

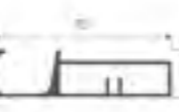

壁厚: 1.2mm 重量: 0.602kg/m

K1463

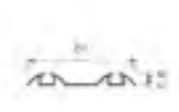

壁厚: 1.0mm 重量: 0.258kg/m

K1461



壁厚: 1.3mm 重量: 0.202kg/m

K1464

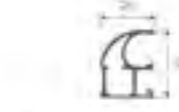

壁厚: 1.2mm 重量: 0.474kg/m

K1465



壁厚: 1.0mm 重量: 0.401kg/m

KXGG-1484

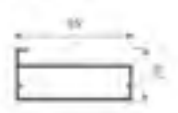

壁厚: 1.0mm 重量: 0.333kg/m

K2237

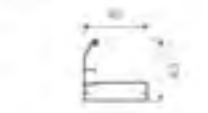

壁厚: 1.2mm 重量: 0.561kg/m

K1840



壁厚: 1.0mm 重量: 0.139kg/m

K1841

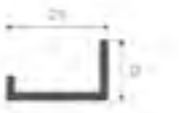

壁厚: 1.0mm 重量: 0.115kg/m

K1466

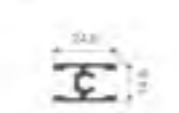

壁厚: 1.2mm 重量: 0.29kg/m

K1467

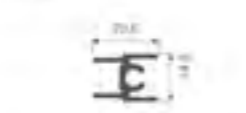

壁厚: 1.2mm 重量: 0.201kg/m

K1468

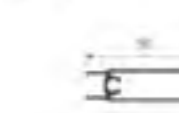

壁厚: 1.0mm 重量: 0.484kg/m









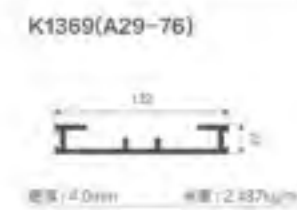
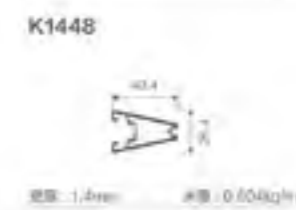
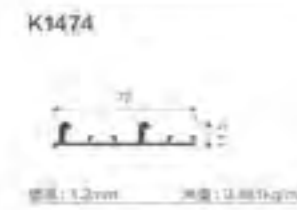
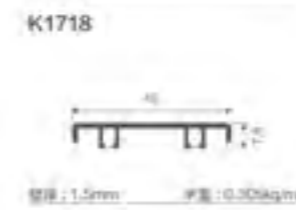
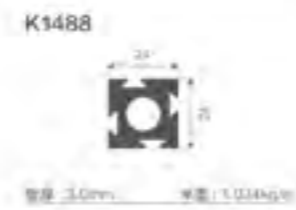
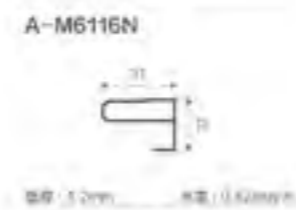
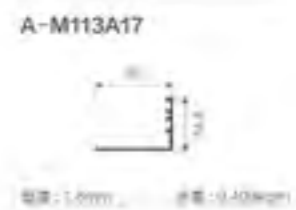
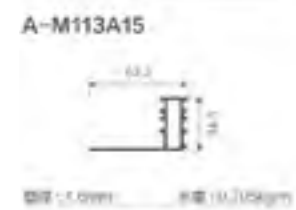
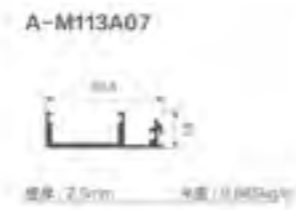
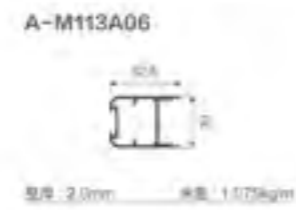
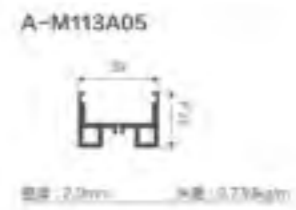
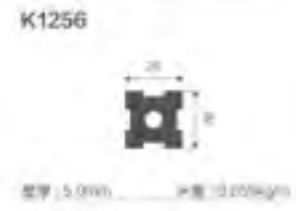
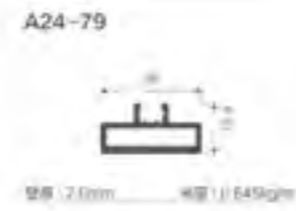
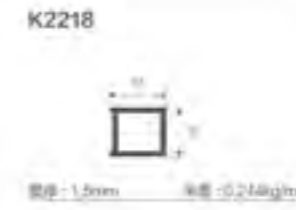
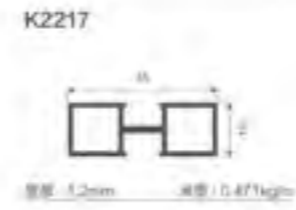
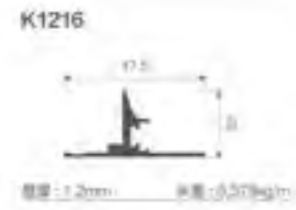
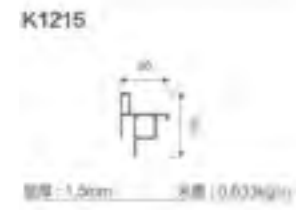

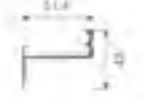

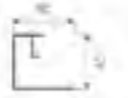





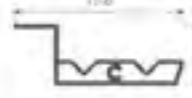
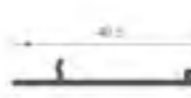
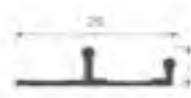
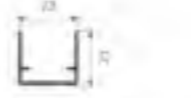

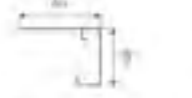
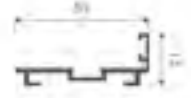
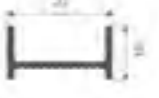

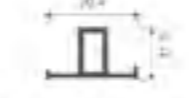

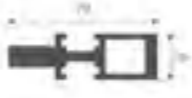

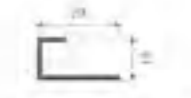
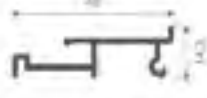

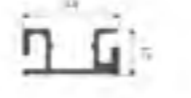
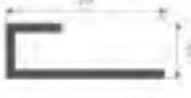
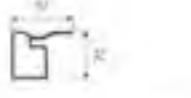
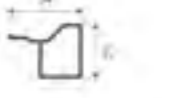
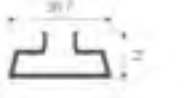
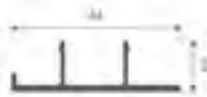

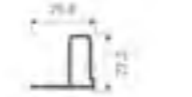
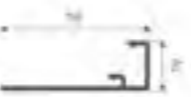



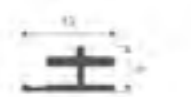

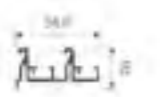

K1461S

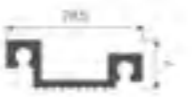
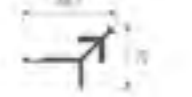

壁厚: 1.2mm 重量: 0.494kg/m

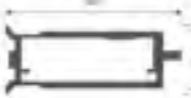
<p>K1680</p> <p>壁厚: 1.2mm 重量: 0.313kg/m</p>	<p>K1681</p> <p>壁厚: 1.2mm 重量: 0.243kg/m</p>	<p>K1682</p> <p>壁厚: 1.2mm 重量: 0.473kg/m</p>	<p>K1683</p> <p>壁厚: 1.2mm 重量: 0.519kg/m</p>	<p>K1861</p> <p>壁厚: 0.8mm 重量: 0.251kg/m</p>	<p>K1862</p> <p>壁厚: 1.0mm 重量: 0.407kg/m</p>	<p>HRP-01</p> <p>壁厚: 1.0mm 重量: 0.303kg/m</p>	<p>HRP-02</p> <p>壁厚: 0.8mm 重量: 0.184kg/m</p>
<p>K1686</p> <p>壁厚: 0.8mm 重量: 0.115kg/m</p>	<p>K1687</p> <p>壁厚: 1.1mm 重量: 0.184kg/m</p>	<p>K1688</p> <p>壁厚: 1.1mm 重量: 0.277kg/m</p>	<p>K1689</p> <p>壁厚: 1.1mm 重量: 0.158kg/m</p>	<p>A-M113A03</p> <p>壁厚: 1.0mm 重量: 1.634kg/m</p>	<p>A-M113A03S</p> <p>壁厚: 1.0mm 重量: 2.254kg/m</p>	<p>A-M113A01</p> <p>壁厚: 2.0mm 重量: 2.650kg/m</p>	<p>A-M113A01D</p> <p>壁厚: 1.0mm 重量: 1.404kg/m</p>
<p>K1690</p> <p>壁厚: 1.1mm 重量: 0.114kg/m</p>	<p>K1765</p> <p>壁厚: 1.0mm 重量: 0.300kg/m</p>	<p>K1766</p> <p>壁厚: 1.1mm 重量: 0.200kg/m</p>	<p>KRC-963</p> <p>壁厚: 1.2mm 重量: 0.579kg/m</p>	<p>A-M113A015</p> <p>壁厚: 3.5mm 重量: 3.953kg/m</p>	<p>K1556</p> <p>壁厚: 1.2mm 重量: 1.073kg/m</p>	<p>K1206</p> <p>壁厚: 1.5mm 重量: 1.324kg/m</p>	<p>K1211</p> <p>壁厚: 1.3mm 重量: 2.180kg/m</p>
<p>KRC-1642</p> <p>壁厚: 1.2mm 重量: 0.513kg/m</p>	<p>K1461S(A31-26)</p> <p>壁厚: 1.2mm 重量: 0.300kg/m</p>	<p>K1300</p> <p>壁厚: 1.2mm 重量: 0.642kg/m</p>	<p>K1880</p> <p>壁厚: 1.3mm 重量: 0.336kg/m</p>	<p>K1230</p> <p>壁厚: 1.0mm 重量: 1.003kg/m</p>	<p>K1585</p> <p>壁厚: 1.3mm 重量: 1.091kg/m</p>	<p>K1486</p> <p>壁厚: 2.0mm 重量: 0.300kg/m</p>	<p>K1758</p> <p>壁厚: 3.0mm 重量: 0.900kg/m</p>
<p>K2122</p> <p>壁厚: 1.2mm 重量: 0.418kg/m</p>	<p>K1817</p> <p>壁厚: 1.2mm 重量: 0.504kg/m</p>	<p>K1818</p> <p>壁厚: 1.0mm 重量: 0.250kg/m</p>	<p>K1983</p> <p>壁厚: 1.4mm 重量: 0.579kg/m</p>	<p>K1847</p> <p>壁厚: 2.0mm 重量: 0.520kg/m</p>	<p>K1666</p> <p>壁厚: 2.3mm 重量: 0.660kg/m</p>	<p>K2233</p> <p>壁厚: 2.0mm 重量: 0.834kg/m</p>	<p>K1554</p> <p>壁厚: 2.5mm 重量: 0.834kg/m</p>
<p>K1984</p> <p>壁厚: 1.0mm 重量: 0.420kg/m</p>	<p>K1985</p> <p>壁厚: 1.2mm 重量: 0.300kg/m</p>	<p>K2184</p> <p>壁厚: 0.9mm 重量: 0.407kg/m</p>	<p>K2185</p> <p>壁厚: 0.9mm 重量: 0.310kg/m</p>	<p>K1555</p> <p>壁厚: 1.0mm 重量: 0.244kg/m</p>	<p>K1914</p> <p>壁厚: 2.5mm 重量: 1.091kg/m</p>	<p>K1915</p> <p>壁厚: 1.0mm 重量: 0.250kg/m</p>	<p>K1916</p> <p>壁厚: 1.0mm 重量: 0.243kg/m</p>
<p>K2186</p> <p>壁厚: 0.9mm 重量: 0.101kg/m</p>	<p>K2123</p> <p>壁厚: 0.9mm 重量: 0.420kg/m</p>	<p>K2124</p> <p>壁厚: 0.9mm 重量: 0.300kg/m</p>	<p>K2230</p> <p>壁厚: 1.1mm 重量: 0.460kg/m</p>	<p>F3112</p> <p>壁厚: 2.5mm 重量: 0.708kg/m</p>	<p>F3113</p> <p>壁厚: 2.5mm 重量: 0.553kg/m</p>	<p>F3114</p> <p>壁厚: 2.5mm 重量: 0.270kg/m</p>	<p>K1214</p> <p>壁厚: 1.1mm 重量: 0.834kg/m</p>

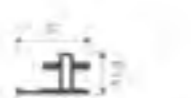

<p>K1370(A29-77)</p>  <p>壁厚: 4.0mm 重量: 1.298kg/m</p>	<p>K122(2MY1886-3)</p>  <p>壁厚: 1.5mm 重量: 0.405kg/m</p>	<p>K1224</p>  <p>壁厚: 1.5mm 重量: 0.653kg/m</p>	<p>K1225</p>  <p>壁厚: 1.5mm 重量: 0.602kg/m</p>	<p>K3208</p>  <p>壁厚: 1.5mm 重量: 1.102kg/m</p>	<p>K3209</p>  <p>壁厚: 2.0mm 重量: 0.232kg/m</p>	<p>K1279A</p>  <p>壁厚: 1.5mm 重量: 0.795kg/m</p>	<p>K1961</p>  <p>壁厚: 1.5mm 重量: 0.141kg/m</p>
<p>K1331</p>  <p>壁厚: 2.0mm 重量: 0.650kg/m</p>	<p>K1357</p>  <p>壁厚: 1.4mm 重量: 0.765kg/m</p>	<p>K1564</p>  <p>壁厚: 1.0mm 重量: 0.134kg/m</p>	<p>K1746</p>  <p>壁厚: 1.0mm 重量: 0.515kg/m</p>	<p>K1962</p>  <p>壁厚: 1.2mm 重量: 0.244kg/m</p>	<p>K1971</p>  <p>壁厚: 2.0mm 重量: 0.262kg/m</p>	<p>K1972</p>  <p>壁厚: 1.1mm 重量: 0.474kg/m</p>	<p>K2221</p>  <p>壁厚: 1.8mm 重量: 0.245kg/m</p>
<p>K1756</p>  <p>壁厚: 1.2mm 重量: 0.517kg/m</p>	<p>5270</p>  <p>壁厚: 1.0mm 重量: 0.209kg/m</p>	<p>5271</p>  <p>壁厚: 1.0mm 重量: 0.201kg/m</p>	<p>K1566N</p>  <p>壁厚: 0.5mm 重量: 0.110kg/m</p>	<p>XGG-1864</p>  <p>壁厚: 2.0mm 重量: 0.034kg/m</p>	<p>XGG-1865</p>  <p>壁厚: 1.2mm 重量: 0.330kg/m</p>	<p>XGG-1866</p>  <p>壁厚: 2.0mm 重量: 0.442kg/m</p>	<p>K2246</p>  <p>壁厚: 1.5mm 重量: 0.276kg/m</p>
<p>F3095</p>  <p>壁厚: 1.2mm 重量: 0.799kg/m</p>	<p>K1750(XAS-9001TS)</p>  <p>壁厚: 2.0mm 重量: 0.710kg/m</p>	<p>KAS-705CDG</p>  <p>壁厚: 1.0mm 重量: 0.126kg/m</p>	<p>K1617</p>  <p>壁厚: 1.0mm 重量: 0.610kg/m</p>	<p>K2247</p>  <p>壁厚: 1.5mm 重量: 0.159kg/m</p>	<p>K2248</p>  <p>壁厚: 1.4mm 重量: 0.415kg/m</p>	<p>K2249</p>  <p>壁厚: 1.4mm 重量: 0.371kg/m</p>	<p>K2253</p>  <p>壁厚: 1.2mm 重量: 0.254kg/m</p>
<p>K1618</p>  <p>壁厚: 1.4mm 重量: 0.242kg/m</p>	<p>K1619</p>  <p>壁厚: 0.8mm 重量: 1.052kg/m</p>	<p>A-M1105P</p>  <p>壁厚: 2.0mm 重量: 0.201kg/m</p>	<p>K1632</p>  <p>壁厚: 1.5mm 重量: 0.219kg/m</p>	<p>K1484N</p>  <p>壁厚: 1.0mm 重量: 0.079kg/m</p>	<p>K1740</p>  <p>壁厚: 1.5mm 重量: 0.159kg/m</p>	<p>K1741</p>  <p>壁厚: 1.5mm 重量: 0.108kg/m</p>	<p>K1716</p>  <p>壁厚: 1.2mm 重量: 0.147kg/m</p>
<p>K1566B</p>  <p>壁厚: 1.0mm 重量: 0.122kg/m</p>	<p>K1644</p>  <p>壁厚: 1.4mm 重量: 0.750kg/m</p>	<p>K1645</p>  <p>壁厚: 1.3mm 重量: 0.509kg/m</p>	<p>K1827</p>  <p>壁厚: 3.0mm 重量: 0.604kg/m</p>	<p>K1728</p>  <p>壁厚: 1.5mm 重量: 0.124kg/m</p>	<p>K1746A</p>  <p>壁厚: 0.7mm 重量: 0.113kg/m</p>	<p>K1755</p>  <p>壁厚: 1.4mm 重量: 0.174kg/m</p>	<p>K1482</p>  <p>壁厚: 1.5mm 重量: 0.209kg/m</p>
<p>K1828</p>  <p>壁厚: 1.5mm 重量: 1.016kg/m</p>	<p>K1827A</p>  <p>壁厚: 2.0mm 重量: 0.550kg/m</p>	<p>K1828A</p>  <p>壁厚: 2.0mm 重量: 0.550kg/m</p>	<p>K1881</p>  <p>壁厚: 2.0mm 重量: 0.754kg/m</p>	<p>K1483</p>  <p>壁厚: 1.0mm 重量: 0.148kg/m</p>	<p>K1484</p>  <p>壁厚: 1.5mm 重量: 0.204kg/m</p>	<p>K1485</p>  <p>壁厚: 1.5mm 重量: 0.214kg/m</p>	<p>K1523</p>  <p>壁厚: 1.7mm 重量: 0.146kg/m</p>

佛山市金洛卡精密五金有限公司
KRC PRECISION HARDWARE CO.,LTD

地址：佛山市南海区狮山镇科技工业园 B 区
博爱东路 7 号 A 栋 02 号

邮编：528000

电话：0757-81827620

传真：0757-81827625

网址：www.krcaluprofiles.com www.jinluoka.com